



FORTRESS[®]
FASTENERS

FASTENERS

PRODUCT GUIDE



PRECISION FASTENERS FOR EVERY PROJECT

For over 40 years, Fortress Fasteners has been supplying kiwi businesses with quality fastening products and professional service. Fortress has grown to be one of the biggest fastening brands in New Zealand, and boasts the largest supply network for industrial fastenings in the country.

From the smallest washer to the largest bolts – and everything in between – Fortress Fasteners can supply your business with our huge in-house stock holdings, as well as access to thousands of products outside our standard product range.



Fortress Fasteners enquiries

0800 42 52 62

sales@steelandtube.co.nz

General enquiries

0800 478 335

sales@steelandtube.co.nz

steelandtube.co.nz

DISCLAIMER: The information in this catalogue is valid as at the date it was prepared. Product lines may be added, expanded or discontinued over time. We carry a large amount of stock at numerous locations around the country however not all items will be available at all locations at all times. This catalogue is intended to provide information to the best of our knowledge in regard to our fasteners range. It does not constitute a complete description of the goods or an express statement about their suitability for any particular purpose. It is intended as a general guide and not as a substitute for advice from a construction professional or the expertise of a qualified tradesperson. This publication may be updated from time to time, please refer to our website for the latest version.

NATIONWIDE LOCATIONS

WHANGAREI

29 Southend Avenue
Raumanga
Ph 09 438 3999

AVONDALE

560 Rosebank Road
Avondale, Auckland
Ph 09 828 2777

ALBANY

2 Ride Way
Albany, Auckland
Ph 09 414 7620

EAST TAMAKI

68 Stonedon Drive
East Tamaki, Auckland
Ph 09 273 7612

HAMILTON

51 Vickery Street
Te Rapa
Ph 07 850 8434

MOUNT MAUNGANUI

7 Newton Street
Mount Manganui
Ph 07 575 0508

NEW PLYMOUTH

21 Swans Rd
Bell Block
Ph 06 824 8950

NAPIER

15 Ford Road
Onekawa
Ph 06 843 9196

PALMERSTON NORTH

20 Francis Way
Roslyn
Ph 06 355 5990

WELLINGTON

6 Regent Street
Petone
Ph 04 586 2300

NELSON

29 Carkeek Street
Port Nelson
Ph 03 548 2209

CHRISTCHURCH

375 Blenheim Road
Upper Riccarton
Ph 03 343 6740

TIMARU

9 Meadows Road
Washdyke
Ph 03 688 2085

DUNEDIN

197 Fryatt Street
Ph 03 477 9655

INVERCARGILL

292 Bond Street
West Invercargill
Ph 03 218 2803



FASTENING APPLICATION RECOMMENDATION

COATING / MATERIAL	CORROSION RESISTANCE	INTERNAL	EXTERNAL EXPOSURE		
			MILD	MODERATE	SEVERE
BLACK/UNPROTECTED		✓			
ZINC CHROMATE	★	✓	✓		
ZINC PLATED	★	✓			
STAINLESS STEEL T304	★★★★	✓	✓	✓	
STAINLESS STEEL T316	★★★★★★	✓	✓	✓	✓
HD GALVANISED	★★★★	✓	✓	✓	
CLASS 3 GALVANISED	★★★	✓	✓		
CLASS 4 GALVANISED	★★★★	✓	✓	✓	
CLASS 5 GALVANISED	★★★★★	✓	✓	✓	✓

DISCLAIMER: This information is correct at the time of printing and recommended as a guide only. To confirm which fastening is right for your project, please refer to your local building regulations or visit www.standards.govt.nz (NZS 3604:2011)

SUSTAINABILITY AND QUALITY FOCUSED

Where possible, we offer low-carbon metals, while ensuring quality and consistency for our customers. Our procurement team and external auditors evaluate suppliers against strict criteria such as Modern Slavery, ESG, Quality Control, Delivery Performance, and more, so that our customers can have peace of mind when buying with Steel & Tube.

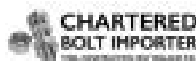

CONTENTS

1 BOLTS, NUTS, WASHERS & THREADED ROD

HEX HEAD BOLT & NUT

Galvanised Class 4.6	20
Zinc Plated Class 4.6	24
Zinc Plated Class 8.8	26
Stainless Steel T304	28
Stainless Steel T316	28
Black Grade 5 UNC	30
Zinc Plated Grade 5 UNC	30
Black Grade 8 UNC	31
Zinc Plated Grade 8 UNC	31
Black Grade 8 UNC	32
Zinc Plated Grade 8 UNC	32
Black Grade 5 UNF	33
Zinc Plated Grade 5 UNF	33
Black Grade 8 UNF	34
Zinc Plated Grade 8 UNF	34

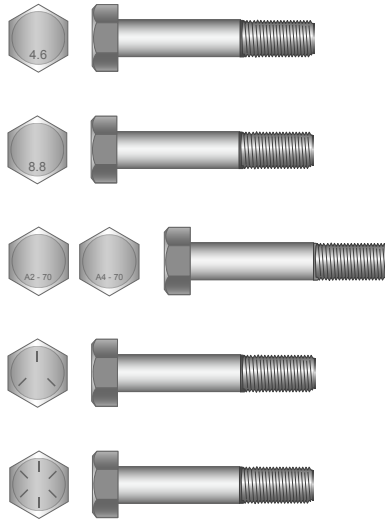

STRUCTURAL FASTENERS

Galvanised HSFG Assemblies 8.8 KO	35
Galvanised HSFG Nuts KO	36
Galvanised HSFG Washers KO	36
Galvanised Assemblies 4.6	37
Galvanised Purlin Flange Assemblies 4.6 & 8.8	37

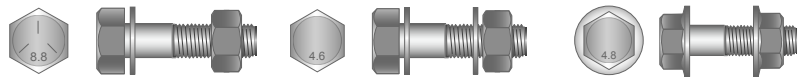

HBS BOLTS

Galvanised HD Grade 8.8	38
-------------------------	----



SHEAR STUDS

Black	39
-------	----



COACH BOLT & NUT

Galvanised Class 4.6	40
Zinc Plated Class 4.6	42
Stainless Steel T304	43
Stainless Steel T316	43
Stainless Steel T304	44
Stainless Steel T316	44





COACH SCREWS

Galvanised Class 4.6	45
Stainless Steel T304	46
Stainless Steel T316	46

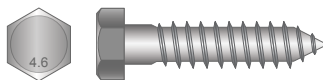

SET SCREWS

Zinc Plated Class 4.6	47
Zinc Plated Class 8.8	48
Zinc Plated Class 8.8 Metric Fine	48
Stainless Steel T304	49
Stainless Steel T316	49
Stainless Steel T304	50
Stainless Steel T316	50
Stainless Steel T304 UNC	51
Stainless Steel T316 UNC	51

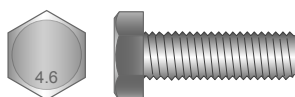

CLOSED EYE BOLTS

Galvanised	52
------------	----



JOINT CONNECTOR BOLTS

Zinc Chromate & Brass Plate	52
Stainless Steel T304	52



COMPONENT HEADS/BARREL NUTS

Stainless Steel T316	53
----------------------	----



GUTTER BOLTS & NUTS

Zinc Plated	53
-------------	----



THREADED ROD

Zinc Plated Class 4.6	54
Zinc Plated Class 8.8	54
Galvanised Class 4.6	54
Galvanised Class 8.8	54
Stainless Steel T304	55
Stainless Steel T304 UNC/UNF	55
Stainless Steel T316	55
Stainless Steel T316 UNF/UNC	55



COUPLING NUTS

Zinc Plated	56
Galvanised	56
Stainless Steel T316	56



CONTENTS

1 BOLTS, NUTS, WASHERS & THREADED ROD

HEX FULL NUTS

Black	57
Zinc Plated	57
Galvanised	57
Stainless Steel T304	58
Black Metric Fine	58
Zinc Plated Metric Fine	58
Stainless Steel T316	58



LOCK NUTS (HALF NUTS)

Zinc Plated	59
Stainless Steel T304	59
Stainless Steel T316	59



TEE NUTS

Zinc Plated	59
-------------	----



DOME NUTS

Stainless Steel T304	60
----------------------	----

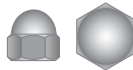

CONE LOCK NUTS

Zinc Plated	60
Stainless Steel T316	60
Brass & Nickel Plate	60

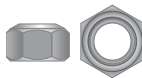

CONE LOCK NUTS - IMPERIAL

Zinc Plated	61
-------------	----

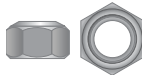

INSERT NUTS

Zinc Plated	62
-------------	----

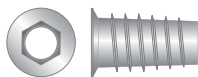

CAGE NUTS

Zinc Chromate	62
---------------	----



NYLOC NUTS

Stainless Steel T304	63
Zinc Plated	63
Galvanised	63
Stainless Steel T316	63



IMPERIAL NYLOC AND HEX FULL NUTS

Stainless Steel T304	64
Stainless Steel T316	64
Black	65





WING NUTS

Stainless Steel T304	65
Zinc Plated	65
Stainless Steel T316	65
Zinc Plated	65



ROUND WASHERS

Zinc Plated	66
Galvanised	67
Black	67



SQUARE WASHERS

Galvanised	68
Stainless Steel T304	68
Stainless Steel T316	68

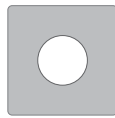

SPRING WASHERS

Stainless Steel T304	69
Stainless Steel T316	69
Zinc Plated	69
Galvanised	69

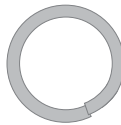

LOCK WASHERS

Zinc Plated	70
Stainless Steel T304	70

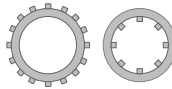

CUP WASHERS

Brass	71
Stainless Steel T304	71



STARLOCK WASHERS

Capped & Uncapped	72
-------------------	----



EPDM WASHERS

Round and Square	72
------------------	----



WEDGE LOCK WASHER

Zinc Flake	73
Stainless Steel T316	73



CONTENTS

2 SCREWS FOR TIMBER

SCREWS FOR TIMBER SELECTION GUIDE

Screw Points information 76

DECKING SCREWS - RAISED CSK

Stainless Steel T304 77

Stainless Steel T316 77



DECKING SCREWS - CSK

T304 Stainless Steel 78

T316 Stainless Steel 78



DECKING SCREWS - BRONZE

BRONZED 304 Stainless Steel 79



DECKING SCREWS

Dimensions 80

SKARA SCREWS - PAN WASHER

Class 4 81



SKARA SCREWS - PAN WASHER

Stainless Steel T304 82



SKARA SCREWS - CSK

Class 4 83

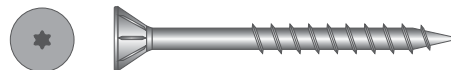

SKARA SCREWS - REAMER

Class 3 83



SKARA SCREWS - CSK

Stainless Steel T304 84



T17 BUGLE BATTEN SCREW

Class 4 85

Stainless Steel T316 85

Zinc Chromate 85



T17 HEX WASHER FACE SCREW

Zinc Chromate 86

Class 4 86

Stainless Steel T304 87

Stainless Steel T316 87



GYPSUM SCREWS

Zinc Chromate 88



SDS GYPSUM SCREW

Zinc Chromate 88



GYPSUM SCREWS COLLATED

Zinc Chromate 89



SDS GYPSUM SCREWS COLLATED

Zinc Chromate 89



COLLATED SUREFAST SCREWS

Zinc Chromate 90



SUREFAST SCREWS

Stainless Steel T304 90
Stainless Steel T316 90
Class 3 91
Zinc Chromate 91

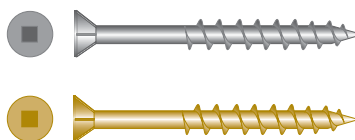

SUREFAST SCREWS PAN SQUARE

Class 4 92

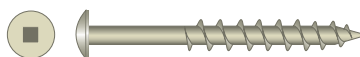

SUREFAST SCREWS PAN POZI

Zinc Chromate 92



PURLIN BLUE SCREW

Blue Ruspert 93



COMPRESSED SHEET SCREW

Stainless Steel T316 93



JOLT HEAD TIMBER SCREW

Class 3 Galvanised 93
Stainless Steel T316 93



TWINFAST SCREWS

Zinc Plated 94

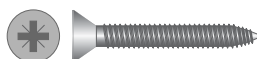

CONTENTS

3 SCREWS FOR METAL

SDS HEX WASHER FACE SCREW

Zinc Chromate	96
Class 4	96
Stainless Steel	97

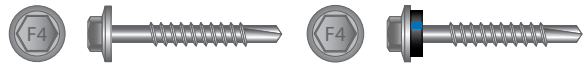

ROOF FAST SCREWS

Class 5	99
---------	----

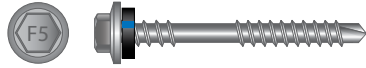

WINGTEK SDS SCREW

Zinc Chromate	102
---------------	-----



SDS SELF EMBED SCREW

Zinc Chromate	102
Class 4	102



SDS WAFER SCREW PHILIPS

Zinc Chromate	103
---------------	-----

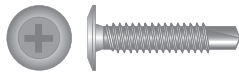

SDS WAFER SCREW SQUARE

Zinc Chromate	103
Class 4	103
Class 4	103

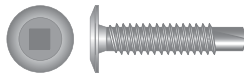

SDS BUTTON SCREW

Zinc Chromate	104
---------------	-----

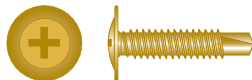

SKARA SCREWS - REAMER

Class 3	104
---------	-----



SELF TAPPING SCREWS

Specifications	105
----------------	-----

SELF TAPPING SCREWS - CSK SQUARE DRIVE

Stainless Steel T304	106
Stainless Steel T304 - #2 Drive	107
Stainless Steel T304 - T17 Point	107
Stainless Steel T304 - Truncated Head	108

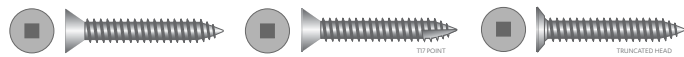

SELF TAPPING SCREWS - PAN SQUARE DRIVE

Stainless Steel T304 - Lead Point	108
Stainless Steel T304	109
Stainless Steel T304 - #2 Drive	110
Stainless Steel T304 - T17 Point	110

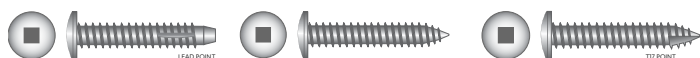



SELF TAPPING SCREWS - PAN POZI

Zinc Plated 111

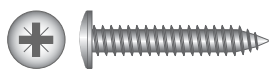

SELF TAPPING SCREWS - CSK POZI

Zinc Plated 112

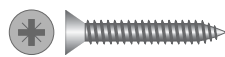

CSK SELF DRILLING SCREWS - BLACK

Stainless Steel T410 113

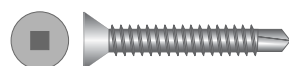

CSK SELF DRILLING SCREWS

Stainless Steel T410 113

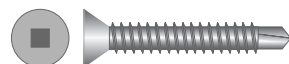

RAISED CSK SELF TAPPING SCREWS TYPE B

Stainless Steel T304 114

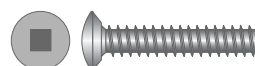

TRUCK DECK SCREWS

Zinc Plated 114

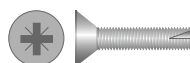

TRUNC SELF TAPPING SCREWS

Stainless Steel T304 115

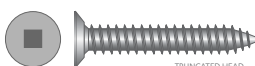

MACHINE SCREWS

Zinc Plated - Pan Pozi 116

Zinc Plated - CSK Slot 117

Zinc Plated - CSK Pozi 117

Zinc Plated - Pan Slot 118

Imperial - Zinc Plated - Pan Slot 119

Stainless Steel T304 - CSK Philips 120

Stainless Steel T304 - Pan Philips 121

Stainless Steel T304 - Cheese Slot 122

Stainless Steel T304 - Pan Slot 122

Stainless Steel T304 - CSK Slot 123

Imperial - Zinc Plated - CSK Slot 123

Imperial - Stainless Steel T304 - RND Slot 124

Imperial - Stainless Steel T304 - CSK Philips 124

Imperial - Stainless Steel T304 - CSK Slot 125

Imperial - Brass - RND Slot 125

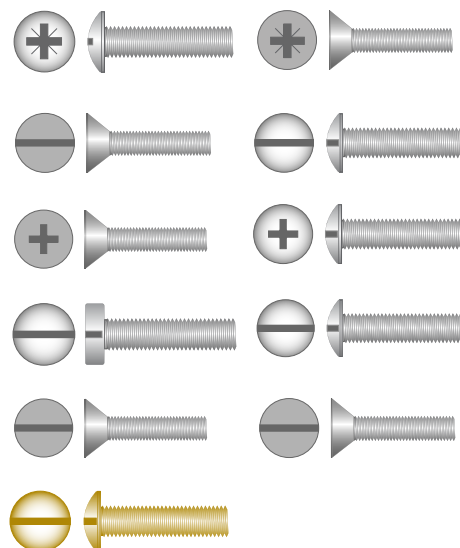

CONTENTS

4 MASONRY ANCHORS

THROUGHBOLTS

Galvanised	128
Bottom Plate Anchor Packs	128
Stainless Steel T316	128

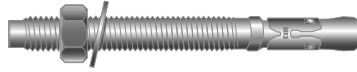

SCREWBOLT ANCHOR

Galvanised	129
------------	-----

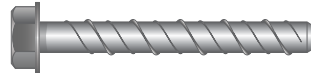

SEISMIC RATED THROUGHBOLTS

Zinc Flake	130
Stainless Steel T316	131

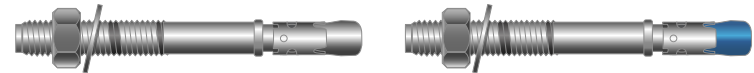

SEISMIC RATED HEX SCREWBOLTS

Zinc Flake	132
------------	-----



SEISMIC RATED CSK SCREWBOLTS

Zinc Flake	133
------------	-----

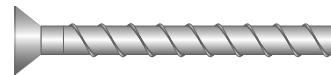

RAWLPLUG

R-KEM II with Threaded Rods for Concrete	134
R-KER-II hybrid resin with Threaded Rods	135
R-KEX II with Rebars as an Anchor	136
Installation guide	137



TX CON MASONRY SCREWS

Hex Head - Mech Galv	138
CSK Head - Mech Galv	138



CHEMICAL STUD ANCHOR

Galvanised	139
Stainless Steel T316	139

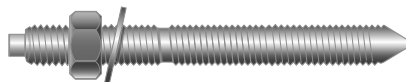

SLEEVE ANCHOR

Galvanised	140
Stainless Steel T316	140
Zinc Chromate	140



HOOK/EYE SLEEVE ANCHOR

Zinc Chromate	141
---------------	-----



CSK SLEEVE ANCHOR

Zinc Chromate	141
---------------	-----



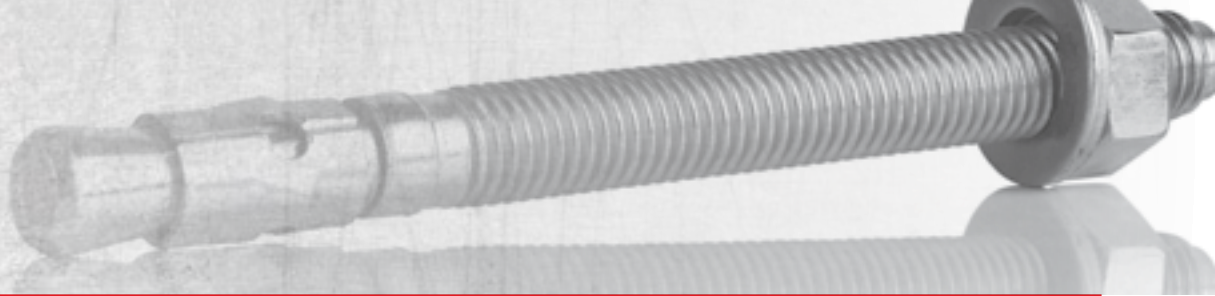

MASONRY NAILS

Carbon Steel Zinc Plated 142

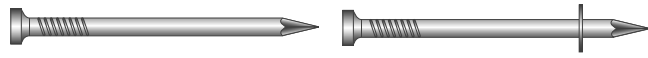

HI-T MUSHROOM ANCHOR

Mech Galvanised 143



HI-T COUNTERSUNK ANCHOR

Mech Galvanised 144



MUSH SPLIT DRIVE ANCHOR

Carbon Steel Zinc Plated 145



CSK SPLIT DRIVE ANCHOR

Carbon Steel Zinc Plated 145



PLASTER BOARD SCREWS

Carbon Steel Zinc Plated / Nylon 146

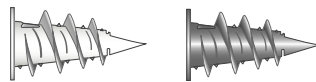

NYLON WALL PLUGS

Nylon 146



MUSH NAIL IN ANCHOR

Carbon Steel Zinc Plated Pin 147

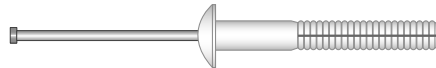

CSK NAIL IN ANCHOR

Carbon Steel Zinc Plated Pin 147

Stainless Steel T304 Pin 147

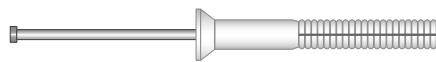

ROUND NAIL IN ANCHOR

Carbon Steel Zinc Plated Pin 148



METAL PIN ANCHOR

Carbon Steel Zinc Plated Pin 148

Stainless Steel T304 Pin 148



MULTI SCREWS

Class 3 149



HOLLOW WALL ANCHORS

Zinc 150



CONTENTS

5 BUILDING HARDWARE

JOIST HANGERS

Stainless Steel	152
Galvanised	152



CYCLONE TIES

Galvanised	152
------------	-----



CEILING HANGERS

Galvanised	153
Stainless Steel	153



CONCEALED PURLIN CLEATS

Stainless Steel	153
Galvanised	153



TIMBA TIES

Stainless Steel	154
Galvanised	154



Z NAILS

Stainless Steel	154
Galvanised	154



MULTI GRIPS

Stainless Steel	155
Galvanised	155



12KN & 6KN PILE FIXING

Stainless Steel	155
-----------------	-----



BRACING BRACKETS

Galvanised	155
------------	-----



STRAPPING

Stainless Steel	156
Galvanised	156



GIRT CONNECTOR

Galvanised	156
------------	-----



OTHER BRACKETS

Stainless Steel	156
Galvanised	156



NAILS AND SCREWS FOR HARDWARE

Stainless Steel	157
Galvanised	157

CONTENTS

6 COLLATED NAILS AND TOOLS

TJEP GRF 34/100 EXCELLENT GAS

Cordless Gas Framing Nailer	161
Consumables	161



TJEP GRF 34/90 GAS 3G

Cordless Gas framing Nailer	162
Consumables	162



TJEP VF-16/64 GAS 3G FINISH NAILER

Cordless 16G Angle Bradder	163
Consumables	163



TJEP AB-15/64 GAS 3G FINISH NAILER

Cordless 15G Angle DA Type Angle Bradder	164
Consumables	164



TJEP CP-40 GAS NAILER

Cordless Concrete Nailer	165
Consumables	165



TJEP ST-15/50 GAS 3G FINISH NAILER

Cordless 15G Straight Bradder	166
Consumables	166



TJEP KA 4060 GAS 3G PRODUCT NAILER

Cordless Product Nailer	167
Consumables	167



TJEP PQZ-75 GAS 3G STAPLER

Cordless Q and N Type stapler	168
Consumables	168



TJEP FS-40 GAS 3G FENCING STAPLER

Cordless Fencing Stapler	169
Consumables	169



TJEP CR 5/9 – 24 BATTERY CORDLESS C-RINGER

Cordless C-Ringer	170
Consumables	170



TJEP ACCESSORIES

TJEP Fuel Cells	171
-----------------	-----



CONTENTS

7 SOCKET SCREWS

CAP SCREWS 12.9

Black	174
Zinc Plated	174
Black - Imperial	178

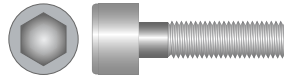

CAP SCREWS

Stainless Steel T304	180
Stainless Steel T316	180

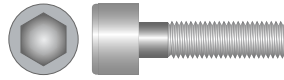

BUTTON HEAD SOCKET SCREWS 12.9

Black	182
Zinc Plated	182
Black	184
Zinc Plated	184

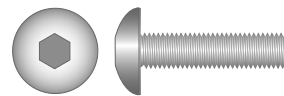

BUTTON HEAD SOCKET SCREWS

Stainless Steel T304	186
Stainless Steel T316	186

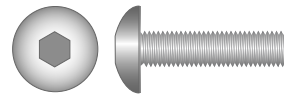

COUNTERSUNK SOCKET SCREWS 10.9

Black	187
Zinc Plated	187
Black - Imperial	191

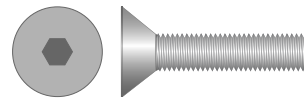

COUNTERSUNK SOCKET SCREWS

Stainless Steel T304	192
Stainless Steel T316	192

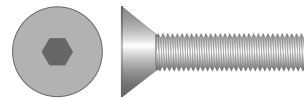

GRUB SCREWS

Black	194
Black - Imperial	195

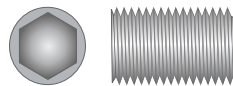

SHOULDER CAP SCREWS

Black	196
-------	-----



CONTENTS

8 RIVETS

DOMED RIVETS

Aluminium / Steel Stem	198
Steel	199
Stainless Steel	199



COUNTERSUNK RIVETS

Aluminium / Steel stem	200
------------------------	-----



LARGE FLANGE RIVETS

Aluminium / Steel stem	200
------------------------	-----

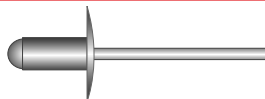

RIVETS

Technical Information	201
-----------------------	-----

FASTENERS THAT DELIVER STRENGTH AND RELIABILITY, EVERY TIME

Fortress Fasteners Enquiries

0800 42 52 62 | sales@steelandtube.co.nz | steelandtube.co.nz

1

BOLTS, NUTS, WASHERS & THREADED ROD



1 BOLTS, NUTS, WASHERS & THREADED ROD

HEX HEAD BOLT & NUT

GALVANISED CLASS 4.6



PART #	SIZE	PACK QTY
BNM820G	M8 X 20	100
BNM825G	M8 X 25	100
BNM830G	M8 X 30	75
BNM835G	M8 X 35	75
BNM840G	M8 X 40	75
BNM845G	M8 X 45	50
BNM850G	M8 X 50	50
BNM855G	M8 X 55	50
BNM865G	M8 X 65	50
BNM875G	M8 X 75	50
BNM890G	M8 X 90	50
BNM8100G	M8 X 100	50
BNM8110G	M8 X 110	50
BNM8120G	M8 X 120	50
BNM1020G	M10 X 20	100
BNM1025G	M10 X 25	100
BNM1030G	M10 X 30	100
BNM1035G	M10 X 35	75
BNM1040G	M10 X 40	75
BNM1045G	M10 X 45	75
BNM1050G	M10 X 50	75
BNM1060G	M10 X 60	50
BNM1065G	M10 X 65	50
BNM1070G	M10 X 70	50
BNM1075G	M10 X 75	50
BNM1080G	M10 X 80	50
BNM1090G	M10 X 90	50
BNM10100G	M10 X 100	50
BNM10110G	M10 X 110	50

PART #	SIZE	PACK QTY
BNM10120G	M10 X 120	50
BNM10130G	M10 X 130	50
BNM10140G	M10 X 140	50
BNM10150G	M10 X 150	50
BNM10160G	M10 X 160	10
BNM10180G	M10 X 180	10
BNM10200G	M10 X 200	10
BNM10220G	M10 X 220	10
BNM10240G	M10 X 240	10
BNM10260G	M10 X 260	10
BNM10280G	M10 X 280	10
BNM10300G	M10 X 300	10
BNM1225G	M12 X 25	75
BNM1230G	M12 X 30	75
BNM1235G	M12 X 35	50
BNM1240G	M12 X 40	50
BNM1245G	M12 X 45	50
BNM1250G	M12 X 50	50
BNM1255G	M12 X 55	50
BNM1260G	M12 X 60	25
BNM1265G	M12 X 65	25
BNM1270G	M12 X 70	25
BNM1275G	M12 X 75	25
BNM1280G	M12 X 80	25
BNM1290G	M12 X 90	25
BNM12100G	M12 X 100	25
BNM12110G	M12 X 110	25
BNM12120G	M12 X 120	25
BNM12130G	M12 X 130	25

PART #	SIZE	PACK QTY
BNM12140G	M12 X 140	25
BNM12150G	M12 X 150	25
BNM12160G	M12 X 160	10
BNM12170G	M12 X 170	10
BNM12180G	M12 X 180	10
BNM12200G	M12 X 200	10
BNM12220G	M12 X 220	10
BNM12240G	M12 X 240	10
BNM12260G	M12 X 260	10
BNM12280G	M12 X 280	10
BNM12300G	M12 X 300	10
BNM12325G	M12 X 325	10
BNM12350G	M12 X 350	10
BNM12375G	M12 X 375	10
BNM12400G	M12 X 400	10
BNM12450G	M12 X 450	10
BNM1625G	M16 X 25	25
BNM1630G	M16 X 30	25
BNM1635G	M16 X 35	25
BNM1640G	M16 X 40	25
BNM1645G	M16 X 45	25
BNM1650G	M16 X 50	25
BNM1655G	M16 X 55	25
BNM1660G	M16 X 60	25
BNM1665G	M16 X 65	20
BNM1670G	M16 X 70	20
BNM1625G	M16 X 25	25
BNM1630G	M16 X 30	25

PART #	SIZE	PACK QTY
BNM1635G	M16 X 35	25
BNM1640G	M16 X 40	25
BNM1645G	M16 X 45	25
BNM1650G	M16 X 50	25
BNM1655G	M16 X 55	25
BNM1660G	M16 X 60	25
BNM1665G	M16 X 65	20
BNM1670G	M16 X 70	20
BNM1675G	M16 X 75	20
BNM1680G	M16 X 80	20
BNM1690G	M16 X 90	20
BNM16100G	M16 X 100	15
BNM16110G	M16 X 110	15
BNM16120G	M16 X 120	15
BNM16130G	M16 X 130	15
BNM16140G	M16 X 140	15
BNM16150G	M16 X 150	15
BNM16160G	M16 X 160	10
BNM16180G	M16 X 180	10
BNM16200G	M16 X 200	10
BNM16220G	M16 X 220	10
BNM16240G	M16 X 240	10
BNM16260G	M16 X 260	10
BNM16280G	M16 X 280	10
BNM16300G	M16 X 300	10
BNM16325G	M16 X 325	5
BNM16350G	M16 X 350	5
BNM16375G	M16 X 375	5

1 BOLTS, NUTS, WASHERS & THREADED ROD

HEX HEAD BOLT & NUT

GALVANISED CLASS 4.6



PART #	SIZE	PACK QTY
BNM16400G	M16 X 400	5
BNM16425G	M16 X 425	5
BNM16450G	M16 X 450	5
BNM16475G	M16 X 475	5
BNM16500G	M16 X 500	5
BNM16525G	M16 X 525	5
BNM16550G	M16 X 550	5
BNM16575G	M16 X 575	5
BNM16600G	M16 X 600	5
BNM2040G	M20 X 40	10
BNM2045G	M20 X 45	10
BNM2050G	M20 X 50	10
BNM2055G	M20 X 55	10
BNM2060G	M20 X 60	10
BNM2065G	M20 X 65	10
BNM2070G	M20 X 70	10
BNM2075G	M20 X 75	10
BNM2080G	M20 X 80	10
BNM2090G	M20 X 90	10
BNM20100G	M20 X 100	10
BNM20110G	M20 X 110	10
BNM20120G	M20 X 120	10
BNM20130G	M20 X 130	10
BNM20140G	M20 X 140	10
BNM20150G	M20 X 150	10
BNM20160G	M20 X 160	10
BNM20180G	M20 X 180	10
BNM20200G	M20 X 200	10
BNM20220G	M20 X 220	10
BNM20240G	M20 X 240	5

PART #	SIZE	PACK QTY
BNM20260G	M20 X 260	5
BNM20280G	M20 X 280	5
BNM20300G	M20 X 300	5
BNM20325G	M20 X 325	5
BNM20350G	M20 X 350	5
BNM20375G	M20 X 375	5
BNM20400G	M20 X 400	5
BNM20450G	M20 X 450	5
BNM20500G	M20 X 500	5
BNM20550G	M20 X 550	5
BNM20600G	M20 X 600	5
BNM2450G	M24 X 50	10
BNM2460G	M24 X 60	10
BNM2465G	M24 X 65	10
BNM2480G	M24 X 80	10
BNM2490G	M24 X 90	10
BNM24100G	M24 X 100	10
BNM24110G	M24 X 110	10
BNM24120G	M24 X 120	10
BNM24130G	M24 X 130	5
BNM24140G	M24 X 140	5
BNM24150G	M24 X 150	5
BNM24160G	M24 X 160	5
BNM24180G	M24 X 180	5
BNM24200G	M24 X 200	5
BNM24220G	M24 X 220	5
BNM24240G	M24 X 240	5
BNM24260G	M24 X 260	5
BNM24280G	M24 X 280	5
BNM24300G	M24 X 300	5

PART #	SIZE	PACK QTY
BNM24350G	M24 X 350	5
BNM24450G	M24 X 450	5
BNM24500G	M24 X 500	5
BNM24550G	M24 X 550	5
BNM24600G	M24 X 600	5
BNM24750G	M24 X 750	5
BNM27120G	M27 X 120	5
BNM30110G	M30 X 110	5
BNM30120G	M30 X 120	5
BNM30130G	M30 X 130	5
BNM30140G	M30 X 140	5
BNM30160G	M30 X 160	5
BNM30180G	M30 X 180	5

1 BOLTS, NUTS, WASHERS & THREADED ROD

HEX HEAD BOLT & NUT

ZINC PLATED CLASS 4.6



PART #	SIZE	PACK QTY
BNM612Z	M6 X 12	200
BNM616Z	M6 X 16	200
BNM620Z	M6 X 20	200
BNM625Z	M6 X 25	200
BNM630Z	M6 X 30	150
BNM635Z	M6 X 35	150
BNM640Z	M6 X 40	150
BNM645Z	M6 X 45	150
BNM650Z	M6 X 50	150
BNM655Z	M6 X 55	150
BNM660Z	M6 X 60	150
BNM665Z	M6 X 65	150
BNM670Z	M6 X 70	150
BNM675Z	M6 X 75	150
BNM680Z	M6 X 80	125
BNM690Z	M6 X 90	100
BNM6100Z	M6 X 100	100
BNM6110Z	M6 X 110	100
BNM820Z	M8 X 20	100
BNM825Z	M8 X 25	75
BNM830Z	M8 X 30	75
BNM835Z	M8 X 35	75
BNM840Z	M8 X 40	75
BNM845Z	M8 X 45	50
BNM850Z	M8 X 50	50
BNM855Z	M8 X 55	50
BNM860Z	M8 X 60	50
BNM865Z	M8 X 65	50
BNM870Z	M8 X 70	50
BNM875Z	M8 X 75	50

PART #	SIZE	PACK QTY
BNM880Z	M8 X 80	75
BNM890Z	M8 X 90	50
BNM8100Z	M8 X 100	50
BNM8110Z	M8 X 110	50
BNM8120Z	M8 X 120	50
BNM1020Z	M10 X 20	100
BNM1025Z	M10 X 25	100
BNM1030Z	M10 X 30	100
BNM1035Z	M10 X 35	75
BNM1040Z	M10 X 40	75
BNM1045Z	M10 X 45	75
BNM1050Z	M10 X 50	75
BNM1060Z	M10 X 60	50
BNM1065Z	M10 X 65	50
BNM1070Z	M10 X 70	50
BNM1075Z	M10 X 75	50
BNM1080Z	M10 X 80	50
BNM1090Z	M10 X 90	50
BNM10100Z	M10 X 100	50
BNM10110Z	M10 X 110	25
BNM10120Z	M10 X 120	25
BNM10130Z	M10 X 130	25
BNM10140Z	M10 X 140	50
BNM10150Z	M10 X 150	50
BNM1225Z	M12 X 25	50
BNM1230Z	M12 X 30	50
BNM1235Z	M12 X 35	50
BNM1240Z	M12 X 40	50
BNM1245Z	M12 X 45	50
BNM1250Z	M12 X 50	50

PART #	SIZE	PACK QTY
BNM1255Z	M12 X 55	50
BNM1260Z	M12 X 60	50
BNM1265Z	M12 X 65	50
BNM1270Z	M12 X 70	50
BNM1280Z	M12 X 80	50
BNM1290Z	M12 X 90	50
BNM12100Z	M12 X 100	25
BNM12110Z	M12 X 110	25
BNM12120Z	M12 X 120	25
BNM12130Z	M12 X 130	25
BNM1630Z	M16 X 30	25
BNM1640Z	M16 X 40	25
BNM1650Z	M16 X 50	25
BNM1660Z	M16 X 60	25
BNM1665Z	M16 X 65	25
BNM1670Z	M16 X 70	25
BNM1675Z	M16 X 75	10
BNM1680Z	M16 X 80	10
BNM1690Z	M16 X 90	10
BNM16100Z	M16 X 100	10
BNM2045Z	M20 X 45	10
BNM2050Z	M20 X 50	10
BNM2065Z	M20 X 65	10
BNM2070Z	M20 X 70	10
BNM2075Z	M20 X 75	10
BNM2090Z	M20 X 90	10
BNM20100Z	M20 X 100	10
BNM20110Z	M20 X 110	10
BNM20140Z	M20 X 140	10

1 BOLTS, NUTS, WASHERS & THREADED ROD

HEX HEAD BOLT & NUT

ZINC PLATED CLASS 8.8



PART #	SIZE	PACK QTY
BNHM616Z	M6 X 16	200
BNHM620Z	M6 X 20	200
BNHM625Z	M6 X 25	200
BNHM630Z	M6 X 30	150
BNHM635Z	M6 X 35	150
BNHM640Z	M6 X 40	150
BNHM645Z	M6 X 45	100
BNHM650Z	M6 X 50	100
BNHM655Z	M6 X 55	100
BNHM660Z	M6 X 60	100
BNHM665Z	M6 X 65	100
BNHM670Z	M6 X 70	100
BNHM680Z	M6 X 80	100
BNHM690Z	M6 X 90	100
BNHM6100Z	M6 X 100	75
BNHM816Z	M8 X 16	125
BNHM820Z	M8 X 20	100
BNHM825Z	M8 X 25	100
BNHM830Z	M8 X 30	75
BNHM835Z	M8 X 35	75
BNHM840Z	M8 X 40	75
BNHM845Z	M8 X 45	50
BNHM850Z	M8 X 50	50
BNHM855Z	M8 X 55	50
BNHM860Z	M8 X 60	50
BNHM865Z	M8 X 65	50
BNHM870Z	M8 X 70	50
BNHM875Z	M8 X 75	50
BNHM880Z	M8 X 80	50
BNHM890Z	M8 X 90	50
BNHM8100Z	M8 X 100	50

PART #	SIZE	PACK QTY
BNHM8110Z	M8 X 110	50
BNHM1020Z	M10 X 20	100
BNHM1025Z	M10 X 25	100
BNHM1030Z	M10 X 30	100
BNHM1035Z	M10 X 35	75
BNHM1040Z	M10 X 40	75
BNHM1050Z	M10 X 50	75
BNHM1055Z	M10 X 55	50
BNHM1060Z	M10 X 60	50
BNHM1065Z	M10 X 65	50
BNHM1070Z	M10 X 70	50
BNHM1075Z	M10 X 75	50
BNHM1080Z	M10 X 80	50
BNHM1090Z	M10 X 90	50
BNHM10100Z	M10 X 100	50
BNHM10110Z	M10 X 110	25
BNHM10120Z	M10 X 120	25
BNHM10130Z	M10 X 130	25
BNHM10140Z	M10 X 140	25
BNHM10150Z	M10 X 150	25
BNHM1225Z	M12 X 25	75
BNHM12130Z	M12 X 30	75
BNHM1235Z	M12 X 35	50
BNHM1240Z	M12 X 40	50
BNHM1245Z	M12 X 45	50
BNHM1250Z	M12 X 50	50
BNHM1255Z	M12 X 55	25
BNHM1260Z	M12 X 60	25
BNHM1265Z	M12 X 65	25
BNHM1270Z	M12 X 70	25
BNHM1275Z	M12 X 75	25

PART #	SIZE	PACK QTY
BNHM1280Z	M12 X 80	25
BNHM1290Z	M12 X 90	25
BNHM12100Z	M12 X 100	25
BNHM12110Z	M12 X 110	25
BNHM12120Z	M12 X 120	25
BNHM12130Z	M12 X 130	25
BNHM12140Z	M12 X 140	25
BNHM12150Z	M12 X 150	25
BNHM12160Z	M12 X 160	25
BNHM12170Z	M12 X 170	25
BNHM12180Z	M12 X 180	25
BNHM12200Z	M12 X 200	10
BNHM1425Z	M14 X 25	25
BNHM1440Z	M14 X 40	25
BNHM1450Z	M14 X 50	25
BNHM1460Z	M14 X 60	25
BNHM14100Z	M14 X 100	25
BNHM16030Z	M16 X 30	25
BNHM1635Z	M16 X 35	25
BNHM1640Z	M16 X 40	25
BNHM1645Z	M16 X 45	25
BNHM1650Z	M16 X 50	25
BNHM1655Z	M16 X 55	25
BNHM1660Z	M16 X 60	25
BNHM1665Z	M16 X 65	25
BNHM1670Z	M16 X 70	20
BNHM1675Z	M16 X 75	20
BNHM1680Z	M16 X 80	20
BNHM1690Z	M16 X 90	20
BNHM16100Z	M16 X 100	15

PART #	SIZE	PACK QTY
BNHM16110Z	M16 X 110	15
BNHM16120Z	M16 X 120	15
BNHM16130Z	M16 X 130	15
BNHM16140Z	M16 X 140	15
BNHM16150Z	M16 X 150	15
BNHM16170Z	M16 X 170	15
BNHM16220Z	M16 X 220	15
BNHM2040Z	M20 X 40	15
BNHM2045Z	M20 X 45	15
BNHM2050Z	M20 X 50	15
BNHM2055Z	M20 X 55	15
BNHM2060Z	M20 X 60	15
BNHM2065Z	M20 X 65	15
BNHM2070Z	M20 X 70	15
BNHM2075Z	M20 X 75	15
BNHM2080Z	M20 X 80	10
BNHM2090Z	M20 X 90	10
BNHM20100Z	M20 X 100	10
BNHM20110Z	M20 X 110	10
BNHM20150Z	M20 X 150	10
BNHM20180Z	M20 X 180	10
BNHM20190Z	M20 X 190	5
BNHM20200Z	M20 X 200	5
BNHM2450Z	M24 X 50	5
BNHM2465Z	M24 X 65	5
BNHM2490Z	M24 X 90	5
BNHM24100Z	M24 X 100	5
BNHM24110Z	M24 X 110	5
BNHM24140Z	M24 X 140	5
BNHM24160Z	M24 X 160	5

1 BOLTS, NUTS, WASHERS & THREADED ROD

HEX HEAD BOLT & NUT

STAINLESS STEEL T304 STAINLESS STEEL T316

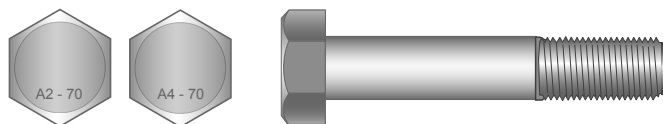

PART #	PART #	SIZE	PACK QTY
BNXM640	BNXM640T	M6 X 40	50
BNXM645	BNXM645T	M6 X 45	50
BNXM650	BNXM650T	M6 X 50	50
BNXM655	BNXM655T	M6 X 55	50
BNXM660	BNXM660T	M6 X 60	50
BNXM665	BNXM665T	M6 X 65	50
BNXM670	BNXM670T	M6 X 70	50
BNXM675	BNXM675T	M6 X 75	50
BNXM680	BNXM680T	M6 X 80	50
BNXM690	BNXM690T	M6 X 90	50
BNXM6130	BNXM6130T	M6 X 130	50
BNXM835	BNXM835T	M8 X 35	25
BNXM840	BNXM840T	M8 X 40	25
BNXM845	BNXM845T	M8 X 45	25
BNXM850	BNXM850T	M8 X 50	25
BNXM865	BNXM865T	M8 X 60	25
BNXM865	BNXM865T	M8 X 65	25
BNXM870	BNXM870T	M8 X 70	25
BNXM880	BNXM880T	M8 X 80	25
BNXM890	BNXM890T	M8 X 90	25
BNXM8100	BNXM8100T	M8 X 100	25
BNXM8110	BNXM8110T	M8 X 110	25
BNXM8130	BNXM8130T	M8 X 130	25
BNXM1040	BNXM1040T	M10 X 40	25
BNXM1050	BNXM1050T	M10 X 50	25
BNXM1060	BNXM1060T	M10 X 60	25
BNXM1065	BNXM1065T	M10 X 65	25
BNXM1070	BNXM1070T	M10 X 70	25
BNXM1075	BNXM1075T	M10 X 75	25
BNXM1080	BNXM1080T	M10 X 80	25
BNXM1090	BNXM1090T	M10 X 90	25

PART #	PART #	SIZE	PACK QTY
BNXM10100	BNXM10100T	M10 X 100	25
BNXM10110	BNXM10110T	M10 X 110	25
BNXM10120	BNXM10120T	M10 X 120	25
BNXM10130	BNXM10130T	M10 X 130	25
BNXM10150	BNXM10150T	M10 X 150	25
BNXM1240	BNXM1240T	M12 X 40	25
BNXM1245	BNXM1245T	M12 X 45	25
BNXM1250	BNXM1250T	M12 X 50	25
BNXM1255	BNXM1255T	M12 X 55	25
BNXM1260	BNXM1260T	M12 X 60	25
BNXM1265	BNXM1265T	M12 X 65	25
BNXM1270	BNXM1270T	M12 X 70	25
BNXM1275	BNXM1275T	M12 X 75	25
BNXM1290	BNXM1290T	M12 X 80	25
BNXM1290	BNXM1290T	M12 X 90	25
BNXM12100	BNXM12100T	M12 X 100	25
BNXM12110	BNXM12110T	M12 X 110	25
BNXM12120	BNXM12120T	M12 X 120	25
BNXM12130	BNXM12130T	M12 X 130	25
BNXM12140	BNXM12140T	M12 X 140	25
BNXM12150	BNXM12150T	M12 X 150	25
BNXM12160	BNXM12160T	M12 X 160	10
BNXM12180	BNXM12180T	M12 X 180	10
BNXM12200	BNXM12200T	M12 X 200	10
BNXM12220	BNXM12220T	M12 X 220	5
BNXM12240	BNXM12240T	M12 X 240	5
BNXM12260	BNXM12260T	M12 X 260	5
BNXM12280	BNXM12280T	M12 X 280	5
BNXM12300	BNXM12300T	M12 X 300	5

HEX HEAD BOLT & NUT

STAINLESS STEEL T304 STAINLESS STEEL T316

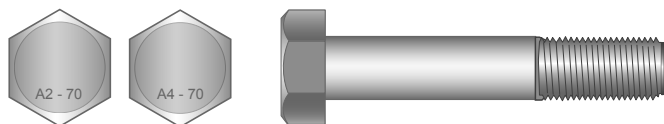

PART #	PART #	SIZE	PACK QTY
BNXM1665	BNXM1665T	M16 X 65	10
BNXM1670	BNXM1670T	M16 X 70	10
BNXM1675	BNXM1675T	M16 X 75	10
BNXM1680	BNXM1680T	M16 X 80	10
BNXM1690	BNXM1690T	M16 X 90	10
BNXM16100	BNXM16100T	M16 X 100	10
BNXM16110	BNXM16110T	M16 X 110	10
BNXM16120	BNXM16120T	M16 X 120	10
BNXM16130	BNXM16130T	M16 X 130	10
BNXM16140	BNXM16140T	M16 X 140	10
BNXM16150	BNXM16150T	M16 X 150	10
BNXM16160	BNXM16160T	M16 X 160	10
BNXM16180	BNXM16180T	M16 X 180	5
BNXM16200	BNXM16200T	M16 X 200	5
BNXM16220	BNXM16220T	M16 X 220	5
BNXM16240	BNXM16240T	M16 X 240	5
BNXM16260	BNXM16260T	M16 X 260	5
BNXM16280	BNXM16280T	M16 X 280	5
BNXM16300	BNXM16300T	M16 X 300	5
BNXM16350	BNXM16350T	M16 X 350	5
BNXM16400	BNXM16400T	M16 X 400	5
BNXM2060	BNXM2060T	M20 X 60	5
BNXM2065	BNXM2065T	M20 X 65	5

PART #	PART #	SIZE	PACK QTY
BNXM2070	BNXM2070T	M20 X 70	5
BNXM2075	BNXM2075T	M20 X 75	5
BNXM2080	BNXM2080T	M20 X 80	5
BNXM2090	BNXM2090T	M20 X 90	5
BNXM20100	BNXM20100T	M20 X 100	5
BNXM20110	BNXM20110T	M20 X 110	5
BNXM20120	BNXM20120T	M20 X 120	5
BNXM20130	BNXM20130T	M20 X 130	5
BNXM20150	BNXM20150T	M20 X 150	5
BNXM20160	BNXM20160T	M20 X 160	5
BNXM20180	BNXM20180T	M20 X 180	5
BNXM20200	BNXM20200T	M20 X 200	5
BNXM20240	BNXM20240T	M20 X 240	5
BNXM20300	BNXM20300T	M20 X 300	5
BNXM2470	BNXM2470T	M24 X 70	5
BNXM2475	BNXM2475T	M24 X 75	5
BNXM2480	BNXM2480T	M24 X 80	5
BNXM2490	BNXM2490T	M24 X 90	5
BNXM24100	BNXM24100T	M24 X 100	5
BNXM24110	BNXM24110T	M24 X 110	5
BNXM24120	BNXM24120T	M24 X 120	5
BNXM24130	BNXM24130T	M24 X 130	5
BNXM24140	BNXM24140T	M24 X 140	5

1 BOLTS, NUTS, WASHERS & THREADED ROD

HEX HEAD BOLT & NUT

BLACK GRADE 5 UNC ZINC PLATED GRADE 5 UNC



PART #	PART #	SIZE	PACK QTY
BNC1412B	BNC1412Z	1/4 X 1/2"	200
BNC1434B	BNC1434Z	1/4 X 3/4"	200
BNC141B	BNC141Z	1/4 X 1"	200
BNC14114B	BNC14114Z	1/4 X 1 1/4"	200
BNC14112B	BNC14112Z	1/4 X 1 1/2"	200
BNC14134B	BNC14134Z	1/4 X 1 3/4"	200
BNC142B	BNC142Z	1/4 X 2"	200
BNC14212B	BNC14212Z	1/4 X 2 1/2"	150
BNC143B	BNC143Z	1/4 X 3"	150
BNC14312B	BNC14312Z	1/4 X 3 1/2"	150
BNC144B	BNC144Z	1/4 X 4"	150
BNC14412B	BNC14412Z	1/4 X 4 1/2"	150
BNC51634B	BNC51634Z	5/16 X 3/4"	200
BNC5161B	BNC5161Z	5/16 X 1"	200
BNC516114B	BNC516114Z	5/16 X 1 1/4"	200
BNC516112B	BNC516112Z	5/16 X 1 1/2"	200
BNC516134B	BNC516134Z	5/16 X 1 3/4"	150
BNC5162B	BNC5162Z	5/16 X 2"	150
BNC516214B	BNC516214Z	5/16 X 2 1/4"	150
BNC516212B	BNC516212Z	5/16 X 2 1/2"	150
BNC516234B	BNC516234Z	5/16 X 2 3/4"	100
BNC5163B	BNC5163Z	5/16 X 3"	100
BNC516312B	BNC516312Z	5/16 X 3 1/2"	100
BNC5164B	BNC5164Z	5/16 X 4"	100
BNC516412B	BNC516412Z	5/16 X 4 1/2"	100
BNC5165B	BNC5165Z	5/16 X 5"	100
BNC5166B	BNC5166Z	5/16 X 6"	100
BNC3834B	BNC3834Z	3/8 X 3/4"	200

PART #	PART #	SIZE	PACK QTY
BNC381B	BNC381Z	3/8 X 1"	200
BNC38114B	BNC38114Z	3/8 X 1 1/4"	200
BNC38112B	BNC38112Z	3/8 X 1 1/2"	150
BNC38134B	BNC38134Z	3/8 X 1 3/4"	150
BNC382B	BNC382Z	3/8 X 2"	100
BNC38214B	BNC38214Z	3/8 X 2 1/4"	100
BNC38212B	BNC38212Z	3/8 X 2 1/2"	100
BNC38234B	BNC38234Z	3/8 X 2 3/4"	100
BNC383B	BNC383Z	3/8 X 3"	100
BNC38312B	BNC38312Z	3/8 X 3 1/2"	50
BNC384B	BNC384Z	3/8 X 4"	50
BNC38412B	BNC38412Z	3/8 X 4 1/2"	50
BNC385B	BNC385Z	3/8 X 5"	50
BNC38512B	BNC38512Z	3/8 X 5 1/2"	50
BNC386B	BNC386Z	3/8 X 6"	50
BNC7161B	BNC7161Z	7/16 X 1"	100
BNC716114B	BNC716114Z	7/16 X 1 1/4"	100
BNC716112B	BNC716112Z	7/16 X 1 1/2"	100
BNC716134B	BNC716134Z	7/16 X 1 3/4"	100
BNC7162B	BNC7162Z	7/16 X 2"	100
BNC716214B	BNC716214Z	7/16 X 2 1/4"	75
BNC716212B	BNC716212Z	7/16 X 2 1/2"	75
BNC716234B	BNC716234Z	7/16 X 2 3/4"	75
BNC7163B	BNC7163Z	7/16 X 3"	75
BNC716312B	BNC716312Z	7/16 X 3 1/2"	75
BNC7164B	BNC7164Z	7/16 X 4"	50
BNC716412B	BNC716412Z	7/16 X 4 1/2"	50
BNC7165B	BNC7165Z	7/16 X 5"	50
BNC716512B	BNC716512Z	7/16 X 5 1/2"	50
BNC7166B	BNC7166Z	7/16 X 6"	50

HEX HEAD BOLT & NUT

BLACK GRADE 8 UNC ZINC PLATED GRADE 8 UNC



PART #	PART #	SIZE	PACK QTY
BNC1234	BNC1234Z	1/2 X 3/4"	22
BNC121	BNC121Z	1/2 X 1"	25
BNC12114	BNC12114Z	1/2 X 1 1/4"	25
BNC12112	BNC12112Z	1/2 X 1 1/2"	25
BNC12134	BNC12134Z	1/2 X 1 3/4"	25
BNC122	BNC122Z	1/2 X 2"	25
BNC12214	BNC12214Z	1/2 X 2 1/4"	25
BNC12212	BNC12212Z	1/2 X 2 1/2"	25
BNC12234	BNC12234Z	1/2 X 2 3/4"	25
BNC123	BNC123Z	1/2 X 3"	25
BNC12314	BNC12314Z	1/2 X 3 1/4"	25
BNC12312	BNC12312Z	1/2 X 3 1/2"	25
BNC12334	BNC12334Z	1/2 X 3 3/4"	25
BNC124	BNC124Z	1/2 X 4"	25
BNC12412	BNC12412Z	1/2 X 4 1/2"	25
BNC125	BNC125Z	1/2 X 5"	25
BNC12512	BNC12512Z	1/2 X 5 1/2"	25
BNC126	BNC126Z	1/2 X 6"	25
BNC12612	BNC12612Z	1/2 X 6 1/2"	25
BNC127	BNC127Z	1/2 X 7"	25
BNC12712	BNC12712Z	1/2 X 7 1/2"	25
BNC128	BNC128Z	1/2 X 8"	25
BNC12812	BNC12812Z	1/2 X 8 1/2"	25
BNC34112B	BNC34112Z	3/4 X 1 1/2"	25
BNC34134B	BNC34134Z	3/4 X 1 3/4"	25
BNC342B	BNC342Z	3/4 X 2"	25
BNC34214B	BNC34214Z	3/4 X 2 1/4"	25
BNC34212B	BNC34212Z	3/4 X 2 1/2"	20
BNC34234B	BNC34234Z	3/4 X 2 3/4"	20
BNC343B	BNC343Z	3/4 X 3"	20

PART #	PART #	SIZE	PACK QTY
BNC34312B	BNC34312Z	3/4 X 3 1/2"	20
BNC344B	BNC344Z	3/4 X 4"	10
BNC34412B	BNC34412Z	3/4 X 4 1/2"	10
BNC345B	BNC345Z	3/4 X 5"	10
BNC34512B	BNC34512Z	3/4 X 5 1/2"	10
BNC346B	BNC346Z	3/4 X 6"	10
BNC34612B	BNC34612Z	3/4 X 6 1/2"	10
BNC347B	BNC347Z	3/4 X 7"	10
BNC34712B	BNC34712Z	3/4 X 7 1/2"	10
BNC348B	BNC348Z	3/4 X 8"	10
BNC349B	BNC349Z	3/4 X 9"	5
BNC3410B	BNC3410Z	3/4 X 10"	5
BNC782B	BNC782Z	7/8 X 2"	10
BNC78214B	BNC78214Z	7/8 X 2 1/4"	10
BNC78212B	BNC78212Z	7/8 X 2 1/2"	10
BNC783B	BNC783Z	7/8 X 3"	10
BNC78312B	BNC78312Z	7/8 X 3 1/2"	10
BNC784B	BNC784Z	7/8 X 4"	10
BNC78412B	BNC78412Z	7/8 X 4 1/2"	10
BNC785B	BNC785Z	7/8 X 5"	10
BNC78512B	BNC78512Z	7/8 X 5 1/2"	10
BNC786B	BNC786Z	7/8 X 6"	10
BNC78612B	BNC78612Z	7/8 X 6 1/2"	5
BNC787B	BNC787Z	7/8 X 7"	5
BNC788B	BNC788Z	7/8 X 8"	5
BNC789B	BNC789Z	7/8 X 9"	5
BNC7810B	BNC7810Z	7/8 X 10"	5
BNC12B	BNC12Z	1 X 2"	5
BNC1212B	BNC1212Z	1 X 2 1/2"	5
BNC13B	BNC13Z	1 X 3"	5
BNC1312B	BNC1312Z	1 X 3 1/2"	5

1 BOLTS, NUTS, WASHERS & THREADED ROD

HEX HEAD BOLT & NUT

BLACK GRADE 8 UNC ZINC PLATED GRADE 8 UNC



PART #	PART #	SIZE	PACK QTY
BNC14B	BNC14Z	1 X 4"	5
BNC1412B	BNC1412Z	1 X 4 1/2"	5
BNC15B	BNC15Z	1 X 5"	5
BNC1612B	BNC1612Z	1 X 6 1/2"	5
BNC17B	BNC17Z	1 X 7"	5
BNC1712B	BNC1712Z	1 X 7 1/2"	5
BNC18B	BNC18Z	1 X 8"	5
BNC1812B	BNC1812Z	1 X 8 1/2"	5
BNC19B	BNC19Z	1 X 9"	5
BNC110B	BNC110Z	1 X 10"	5
BNC1183B	BNC1183Z	1.1/8 X 3"	5
BNC118312B	BNC118312Z	1.1/8 X 3 1/2"	5
BNC1184B	BNC1184Z	1.1/8 X 4"	5
BNC118412B	BNC118412Z	1.1/8 X 4 1/2"	5
BNC1185B	BNC1185Z	1.1/8 X 5"	5
BNC1186B	BNC1186Z	1.1/8 X 6"	5
BNC1188B	BNC1188Z	1.1/8 X 8"	5
BNC1189B	BNC1189Z	1.1/8 X 9"	5
BNC11810B	BNC11810Z	1.1/8 X 10"	5
BNC1143B	BNC1143Z	1.1/4 X 3"	4
BNC114312B	BNC114312Z	1.1/4 X 3 1/2"	4

HEX HEAD BOLT & NUT

BLACK GRADE 5 UNF ZINC PLATED GRADE 5 UNF



PART #	PART #	SIZE	PACK QTY
BNF1434B	BNF1434Z	1/4 X 3/4"	200
BNF141B	BNF141Z	1/4 X 1"	200
BNF14114B	BNF14114Z	1/4 X 1 1/4"	200
BNF14112B	BNF14112Z	1/4 X 1 1/2"	200
BNF142B	BNF142Z	1/4 X 2"	200
BNF14212B	BNF14212Z	1/4 X 2 1/2"	150
BNF143B	BNF143Z	1/4 X 3"	150
BNF144B	BNF144Z	1/4 X 4"	150
BNF51634B	BNF51634Z	5/16 X 3/4"	200
BNF5161B	BNF5161Z	5/16 X 1"	200
BNF516114B	BNF516114Z	5/16 X 1 1/4"	200
BNF516112B	BNF516112Z	5/16 X 1 1/2"	200
BNF5162B	BNF5162Z	5/16 X 2"	150
BNF516212B	BNF516212Z	5/16 X 2 1/2"	150
BNF5163B	BNF5163Z	5/16 X 3"	100
BNF516312B	BNF516312Z	5/16 X 3 1/2"	100
BNF5164B	BNF5164Z	5/16 X 4"	100
BNF5166B	BNF5166Z	5/16 X 6"	100
BNF3834B	BNF3834Z	3/8 X 3/4"	200
BNF381B	BNF381Z	3/8 X 1"	200
BNF38114B	BNF38114Z	3/8 X 1 1/4"	200

PART #	PART #	SIZE	PACK QTY
BNF38112B	BNF38112Z	3/8 X 1 1/2"	150
BNF38134B	BNF38134Z	3/8 X 1 3/4"	150
BNF382B	BNF382Z	3/8 X 2"	100
BNF38214B	BNF38214Z	3/8 X 2 1/4"	100
BNF38212B	BNF38212Z	3/8 X 2 1/2"	100
BNF383B	BNF383Z	3/8 X 3"	100
BNF38312B	BNF38312Z	3/8 X 3 1/2"	50
BNF384B	BNF384Z	3/8 X 4"	50
BNF38412B	BNF38412Z	3/8 X 4 1/2"	50
BNF385B	BNF385Z	3/8 X 5"	50
BNF7161B	BNF7161Z	7/16 X 1"	100
BNF716114B	BNF716114Z	7/16 X 1 1/4"	100
BNF716112B	BNF716112Z	7/16 X 1 1/2"	100
BNF7162B	BNF7162Z	7/16 X 2"	100
BNF716212B	BNF716212Z	7/16 X 2 1/2"	75
BNF7163B	BNF7163Z	7/16 X 3"	75
BNF716312B	BNF716312Z	7/16 X 3 1/2"	75
BNF7164B	BNF7164Z	7/16 X 4"	50
BNF716412B	BNF716412Z	7/16 X 4 1/2"	50
BNF7165B	BNF7165Z	7/16 X 5"	50

1 BOLTS, NUTS, WASHERS & THREADED ROD

HEX HEAD BOLT & NUT

BLACK GRADE 8 UNF ZINC PLATED GRADE 8 UNF



PART #	PART #	SIZE	PACK QTY
BNF1234B	BNF1234Z	1/2 X 3/4"	75
BNF121B	BNF121Z	1/2 X 1"	75
BNF12114B	BNF12114Z	1/2 X 1 1/4"	75
BNF12112B	BNF12112Z	1/2 X 1 1/2"	75
BNF12134B	BNF12134Z	1/2 X 1 3/4"	75
BNF122B	BNF122Z	1/2 X 2"	50
BNF12214B	BNF12214Z	1/2 X 2 1/4"	50
BNF12214B	BNF12214Z	1/2 X 2 1/2"	50
BNF12234B	BNF12234Z	1/2 X 2 3/4"	50
BNF123B	BNF123Z	1/2 X 3"	25
BNF12312B	BNF12312Z	1/2 X 3 1/2"	25
BNF124B	BNF124Z	1/2 X 4"	25
BNF12412B	BNF12412Z	1/2 X 4 1/2"	25
BNF125B	BNF125Z	1/2 X 5"	25
BNF12512B	BNF12512Z	1/2 X 5 1/2"	25
BNF126B	BNF126Z	1/2 X 6"	25
BNF12612B	BNF12612Z	1/2 X 6 1/2"	20
BNF127B	BNF127Z	1/2 X 7"	20
BNF128B	BNF128Z	1/2 X 8"	20
BNF916112B	BNF916112Z	9/16 X 1 1/2"	25
BNF9162B	BNF9162Z	9/16 X 2"	25

PART #	PART #	SIZE	PACK QTY
BNF916212B	BNF916212Z	9/16 X 2 1/2"	25
BNF9163B	BNF9163Z	9/16 X 3"	25
BNF916312B	BNF916312Z	9/16 X 3 1/2"	25
BNF9164B	BNF9164Z	9/16 X 4"	25
BNF581B	BNF581Z	5/8 X 1"	25
BNF58114B	BNF58114Z	5/8 X 1 1/4"	25
BNF58112B	BNF58112Z	5/8 X 1 1/2"	25
BNF58134B	BNF58134Z	5/8 X 1 3/4"	25
BNF582B	BNF582Z	5/8 X 2"	25
BNF58214B	BNF58214Z	5/8 X 2 1/4"	25
BNF58212B	BNF58212Z	5/8 X 2 1/2"	25
BNF58234B	BNF58234Z	5/8 X 2 3/4"	25
BNF583B	BNF583Z	5/8 X 3"	25
BNF58312B	BNF58312Z	5/8 X 3 1/2"	25
BNF584B	BNF584Z	5/8 X 4"	25
BNF58412B	BNF58412Z	5/8 X 4 1/2"	15
BNF585B	BNF585Z	5/8 X 5"	15
BNF58512B	BNF58512Z	5/8 X 5 1/2"	15
BNF586B	BNF586Z	5/8 X 6"	15
BNF58612B	BNF58612Z	5/8 X 6 1/2"	15

STRUCTURAL FASTENERS

GALVANISED HSFG ASSEMBLIES 8.8 KO

Different sizes available on request.

Test certificates also available.

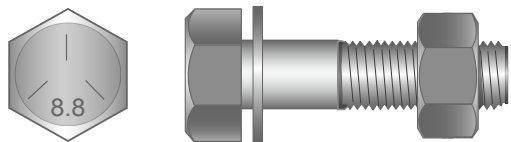

PART #	SIZE	PACK QTY
HSFGM1640GK0	M16 X 40	EACH
HSFGM1645GK0	M16 X 45	EACH
HSFGM1650GK0	M16 X 50	EACH
HSFGM1655GK0	M16 X 55	EACH
HSFGM1660GK0	M16 X 60	EACH
HSFGM1665GK0	M16 X 65	EACH
HSFGM1670GK0	M16 X 70	EACH
HSFGM1675GK0	M16 X 75	EACH
HSFGM1680GK0	M16 X 80	EACH
HSFGM1690GK0	M16 X 90	EACH
HSFGM16100GK0	M16 X 100	EACH
HSFGM16110GK0	M16 X 110	EACH
HSFGM16120GK0	M16 X 120	EACH
HSFGM16130GK0	M16 X 130	EACH
HSFGM16140GK0	M16 X 140	EACH
HSFGM16150GK0	M16 X 150	EACH
HSFGM16180GK0	M16 X 180	EACH
HSFGM16200GK0	M16 X 200	EACH
HSFGM2040GK0	M20 X 40	EACH
HSFGM2045GK0	M20 X 45	EACH
HSFGM2050GK0	M20 X 50	EACH
HSFGM2055GK0	M20 X 55	EACH
HSFGM2060GK0	M20 X 60	EACH
HSFGM2065GK0	M20 X 65	EACH
HSFGM2070GK0	M20 X 70	EACH
HSFGM2080GK0	M20 X 80	EACH
HSFGM2009GK0	M20 X 90	EACH
HSFGM20100GK0	M20 X 100	EACH
HSFGM20110GK0	M20 X 110	EACH
HSFGM20120GK0	M20 X 120	EACH
HSFGM20130GK0	M20 X 130	EACH

PART #	SIZE	PACK QTY
HSFGM20150GK0	M20 X 150	EACH
HSFGM20200GK0	M20 X 200	EACH
HSFGM2450GK0	M24 X 50	EACH
HSFGM2455GK0	M24 X 55	EACH
HSFGM2460GK0	M24 X 60	EACH
HSFGM2465GK0	M24 X 65	EACH
HSFGM2470GK0	M24 X 70	EACH
HSFGM2475GK0	M24 X 75	EACH
HSFGM2480GK0	M24 X 80	EACH
HSFGM2485GK0	M24 X 85	EACH
HSFGM2490GK0	M24 X 90	EACH
HSFGM24100GK0	M24 X 100	EACH
HSFGM24110GK0	M24 X 110	EACH
HSFGM24120GK0	M24 X 120	EACH
HSFGM24130GK0	M24 X 130	EACH
HSFGM24150GK0	M24 X 150	EACH
HSFGM24160GK0	M24 X 160	EACH
HSFGM24180GK0	M24 X 180	EACH
HSFGM3075GK0	M30 X 75	EACH
HSFGM3080GK0	M30 X 80	EACH
HSFGM3090GK0	M30 X 90	EACH
HSFGM30100GK0	M30 X 100	EACH
HSFGM30110GK0	M30 X 110	EACH
HSFGM30120GK0	M30 X 120	EACH
HSFGM30130GK0	M30 X 130	EACH
HSFGM30150GK0	M30 X 150	EACH
HSFGM3690GK0	M36 X 90	EACH
HSFGM36100GK0	M36 X 100	EACH
HSFGM36120GK0	M36 X 120	EACH
HSFGM36130GK0	M36 X 130	EACH
HSFGM36140GK0	M36 X 140	EACH

1 BOLTS, NUTS, WASHERS & THREADED ROD

STRUCTURAL FASTENERS

GALVANISED HSFG NUTS K0



PART #	SIZE	PACK QTY
HSFGNM16GK0	M16	50
HSFGNM20GK0	M20	50
HSFGNM22GK0	M22 - ON REQUEST ONLY	25
HSFGNM24GK0	M24	25
HSFGNM30GK0	M30	25
HSFGNM36GK0	M36	25

GALVANISED HSFG WASHERS K0



PART #	SIZE	PACK QTY
HSFGWM16GK0	M16	100
HSFGWM20GK0	M20	50
HSFGWM22GK0	M22 - ON REQUEST ONLY	50
HSFGWM24GK0	M24	50
HSFGWM30GK0	M30	50
HSFGWM36GK0	M36	50

STRUCTURAL FASTENERS

GALVANISED ASSEMBLIES 4.6

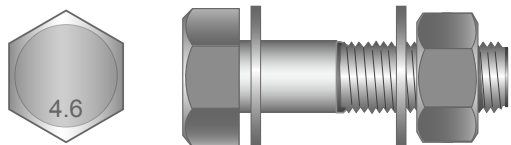

PART #	SIZE	PACK QTY
BNM1230GA	M12 X 30	EACH
BNM1235A	M12 X 35	EACH
BNM1240GA	M12 X 40	EACH
BNM1250GA	M12 X 50	EACH
BNM1630GA	M16 X 30	EACH
BNM1635GA	M16 X 35	EACH

PART #	SIZE	PACK QTY
BNM1640GA	M16 X 40	EACH
BNM1645GA	M16 X 45	EACH
BNM1650GA	M16 X 50	EACH
BNM1680GA	M16 X 80	EACH
BNM2070GA	M20 X 70	EACH
BNM2090GA	M20 X 90	EACH

GALVANISED PURLIN FLANGE ASSEMBLIES 4.6 & 8.8

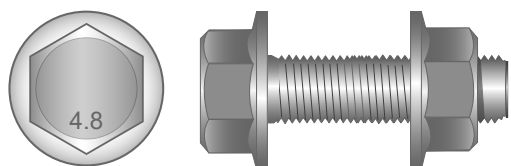

PART #	PART #	SIZE	PACK QTY
BNM1230PZ (ZINC)	BNM1230PG	M12 X 30	EACH
BNM1635PZ	BNM1635PG	M16 X 35	EACH
	BNHM1230PG	M12 X 30 CLASS 8.8	EACH
	BNHM1635PG	M16 X 35 CLASS 8.8	EACH

1 BOLTS, NUTS, WASHERS & THREADED ROD

HBS BOLTS

GALVANISED HD GRADE 8.8

PART #	SIZE	GRIP RANGE	HOLE SIZE REQUIRED
HEX			
CFHBBH850G	M8 X 50	3-22mm	14mm
CFHBBH870G	M8 X 70	22-41mm	14mm
CFHBBH890G	M8 X 90	41-60mm	14mm
CFHBBH1055G	M10 X 55	3-22mm	18mm
CFHBBH1070G	M10 X 70	22-41mm	18mm
CFHBBH1090G	M10 X 90	41-60mm	18mm
CFHBBH1260G	M12 X 60	3-25mm	20mm
CFHBBH1280G	M12 X 80	25-47mm	20mm
CFHBBH12110G	M12 X 110	47-69mm	20mm
CFHBBH1680G	M16 X 80	12-29mm	26mm
CFHBBH16100G	M16 X 100	29-50mm	26mm
CFHBBH16120G	M16 X 120	50-71mm	26mm
CFHBBH2090G	M20 X 90	12-34mm	33mm
CFHBBH20120G	M20 X 120	34-60mm	33mm
CFHBBH20140G	M20 X 140	60-86mm	33mm
CSK			
CFHBC850G	M8 X 50	3-22mm	14mm
CFHBC870G	M8 X 70	22-41mm	14mm
CFHBC890G	M8 X 90	41-60mm	14mm
CFHBC1050G	M10 X 50	3-22mm	18mm
CFHBC1070G	M10 X 70	22-41mm	18mm
CFHBC1090G	M10 X 90	41-60mm	18mm
CFHBC1255G	M12 X 55	3-25mm	20mm
CFHBC1280G	M12 X 80	25-47mm	20mm
CFHBC12100G	M12 X 100	47-69mm	20mm
CFHBC1670G	M16 X 70	12-29mm	26mm
CFHBC16100G	M16 X 100	29-50mm	26mm
CFHBC16120G	M16 X 120	50-71mm	26mm
FLUSH FIT			
CFHBF850G	M8 X 50	8-27mm	14mm
CFHBF870G	M8 X 70	27-46mm	14mm
CFHBF890G	M8 X 90	46-65mm	14mm
CFHBF1050G	M10 X 50	9-28mm	18mm
CFHBF1070G	M10 X 70	28-47mm	18mm
CFHBF1090G	M10 X 90	47-66mm	18mm
CFHBF1255G	M12 X 55	10-32mm	20mm
CFHBF1280G	M12 X 80	32-54mm	20mm
CFHBF12100G	M12 X 100	54-76mm	20mm
CFHBFTOOLM8	M8		
CFHBFTOOLM10	M10		
CFHBFTOOLM12	M12		



HEX



CSK



FLUSH FIT



Flush Fit Sleeve
Setting nut needed for installation. 1x install tool included in each carton.

SHEAR STUDS

BLACK

Standard Manufactured to AS/NZS 1554.2:2003

All sizes listed are Length After Weld (LAW)



PART #	SIZE	PACK QTY
SHEARM16FER	M16	500
SHEARM16FERT	M16	400
SHEARM16100	M16 x 100mm	130
SHEARM16145	M16 x 145mm	95
SHEARM19FER	M19	400
SHEARM19FERT	M19	400
SHEARM19100	M19 x 100mm	100
SHEARM19120	M19 x 120mm	85
SHEARM19125	M19 x 125mm	80
SHEARM19140	M19 x 140mm	70
SHEARM19150	M19 x 150mm	65
SHEARM19175	M19 x 175mm	40
SHEARM19200	M19 x 200mm	50
SHEARM19250	M19 x 250mm	45
SHEARM1950	M19 x 50mm	160
SHEARM1975	M19 x 75mm	120
SHEARM1980	M19 x 80mm	120
SHEARM1990	M19 x 90mm	100
SHEARM22FER	M22	250
SHEARM22FERT	M22	250
SHEARM22100	M22 x 100mm	70
SHEARM22125	M22 x 125mm	60
SHEARM22150	M22 x 150mm	50
SHEARM22175	M22 x 175mm	40
SHEARM22200	M22 x 200mm	40



1 BOLTS, NUTS, WASHERS & THREADED ROD

COACH BOLT & NUT

GALVANISED CLASS 4.6

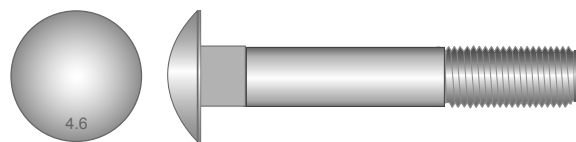

PART #	SIZE	PACK QTY
CBNM820G	M8 X 20	100
CBNM825G	M8 X 25	100
CBNM830G	M8 X 30	75
CBNM840G	M8 X 40	75
CBNM850G	M8 X 50	50
CBNM860G	M8 X 60	50
CBNM865G	M8 X 65	50
CBNM875G	M8 X 75	50
CBNM880G	M8 X 80	50
CBNM890G	M8 X 90	50
CBNM895G	M8 X 95	50
CBNM8100G	M8 X 100	50
CBNM8110G	M8 X 110	50
CBNM8130G	M8 X 130	50
CBNM8140G	M8 X 140	50
CBNM8150G	M8 X 150	50
CBNM8160G	M8 X 160	50
CBNM8180G	M8 X 180	50
CBNM1025G	M10 X 25	100
CBNM1030G	M10 X 30	100
CBNM1040G	M10 X 40	75
CBNM1050G	M10 X 50	75
CBNM1060G	M10 X 60	50
CBNM1065G	M10 X 65	50
CBNM1070G	M10 X 70	50
CBNM1075G	M10 X 75	50
CBNM1080G	M10 X 80	50
CBNM1090G	M10 X 90	50
CBNM10100G	M10 X 100	50
CBNM10110G	M10 X 110	50
CBNM10120G	M10 X 120	50

PART #	SIZE	PACK QTY
CBNM10130G	M10 X 130	50
CBNM10140G	M10 X 140	50
CBNM10150G	M10 X 150	50
CBNM10160G	M10 X 160	10
CBNM10170G	M10 X 170	10
CBNM10180G	M10 X 180	10
CBNM10190G	M10 X 190	10
CBNM10200G	M10 X 200	10
CBNM10220G	M10 X 220	10
CBNM10240G	M10 X 240	10
CBNM10260G	M10 X 260	10
CBNM10280G	M10 X 280	10
CBNM10300G	M10 X 300	10
CBNM10350G	M10 X 350	10
CBNM1230G	M12 X 30	50
CBNM1240G	M12 X 40	50
CBNM1250G	M12 X 50	50
CBNM1260G	M12 X 60	25
CBNM1265G	M12 X 65	25
CBNM1270G	M12 X 70	25
CBNM1275G	M12 X 75	25
CBNM1290G	M12 X 90	25
CBNM12100G	M12 X 100	25
CBNM12110G	M12 X 110	25
CBNM12120G	M12 X 120	25
CBNM12130G	M12 X 130	25
CBNM12140G	M12 X 140	25
CBNM12150G	M12 X 150	25
CBNM12160G	M12 X 160	10
CBNM12170G	M12 X 170	10
CBNM12180G	M12 X 180	10

PART #	SIZE	PACK QTY
CBNM12190G	M12 X 190	10
CBNM12200G	M12 X 200	10
CBNM12220G	M12 X 220	10
CBNM12240G	M12 X 240	10
CBNM12260G	M12 X 260	10
CBNM12280G	M12 X 280	10
CBNM12300G	M12 X 300	10
CBNM12325G	M12 X 325	10
CBNM12350G	M12 X 350	10
CBNM12375G	M12 X 375	10
CBNM12400G	M12 X 400	10
CBNM1650G	M16 X 50	10
CBNM1665G	M16 X 65	10
CBNM1675G	M16 X 75	10
CBNM1690G	M16 X 90	10
CBNM16100G	M16 X 100	10
CBNM16110G	M16 X 110	10
CBNM16150G	M16 X 150	10
CBNM16160G	M16 X 160	10
CBNM16180G	M16 X 180	10

PART #	SIZE	PACK QTY
CBNM16200G	M16 X 200	10
CBNM16220G	M16 X 220	10
CBNM16240G	M16 X 240	10
CBNM16250G	M16 X 250	10
CBNM16260G	M16 X 260	10
CBNM16280G	M16 X 280	10
CBNM16300G	M16 X 300	5
CBNM16325G	M16 X 325	5
CBNM16350G	M16 X 350	5
CBNM16400G	M16 X 400	5
CBNM20100G	M20 X 100	5
CBNM20130G	M20 X 130	5
CBNM20150G	M20 X 150	5
CBNM20180G	M20 X 180	5
CBNM20200G	M20 X 200	5
CBNM20240G	M20 X 240	5
CBNM20260G	M20 X 260	5
CBNM20300G	M20 X 300	5
CBNM20350G	M20 X 350	5
CBNM20450G	M20 X 450	5

1 BOLTS, NUTS, WASHERS & THREADED ROD

COACH BOLT & NUT

ZINC PLATED CLASS 4.6

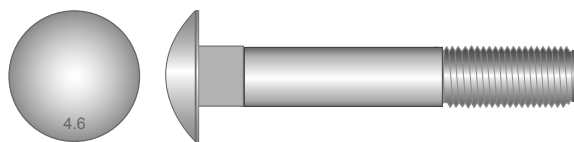

PART #	SIZE	PACK QTY
CBNM620Z	M6 X 20	200
CBNM625Z	M6 X 25	200
CBNM630Z	M6 X 30	150
CBNM635Z	M6 X 35	150
CBNM640Z	M6 X 40	150
CBNM650Z	M6 X 50	150
CBNM655Z	M6 X 55	150
CBNM660Z	M6 X 60	150
CBNM665Z	M6 X 65	150
CBNM670Z	M6 X 70	150
CBNM675Z	M6 X 75	125
CBNM690Z	M6 X 90	100
CBNM6100Z	M6 X 100	100
CBNM6110Z	M6 X 110	100
CBNM6130Z	M6 X 130	100
CBNM6150Z	M6 X 150	100
CBNM820Z	M8 X 20	100
CBNM825Z	M8 X 25	100
CBNM830Z	M8 X 30	75
CBNM840Z	M8 X 40	75
CBNM845Z	M8 X 45	50

PART #	SIZE	PACK QTY
CBNM850Z	M8 X 50	50
CBNM860Z	M8 X 60	50
CBNM865Z	M8 X 65	50
CBNM870Z	M8 X 70	50
CBNM875Z	M8 X 75	50
CBNM880Z	M8 X 80	50
CBNM890Z	M8 X 90	50
CBNM8100Z	M8 X 100	50
CBNM8110Z	M8 X 110	50
CBNM8150Z	M8 X 150	50
CBNM1020Z	M10 X 20	100
CBNM1025Z	M10 X 25	100
CBNM1030Z	M10 X 30	100
CBNM1040Z	M10 X 40	75
CBNM1050Z	M10 X 50	75
CBNM1065Z	M10 X 65	50
CBNM1090Z	M10 X 90	50
CBNM10100Z	M10 X 100	50
CBNM10110Z	M10 X 110	50
CBNM10130Z	M10 X 130	50

COACH BOLT & NUT

STAINLESS STEEL T304 STAINLESS STEEL T316

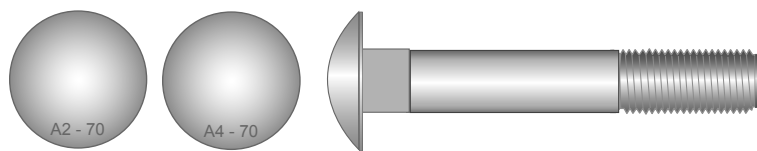

PART #	PART #	SIZE	PACK QTY
CBNXM625	CBNXM625T	M6 X 25	50
CBNXM630	CBNXM630T	M6 X 30	50
CBNXM640	CBNXM640T	M6 X 40	50
CBNXM650	CBNXM650T	M6 X 50	50
CBNXM660	CBNXM660T	M6 X 60	50
CBNXM675	CBNXM675T	M6 X 75	50
CBNXM680	CBNXM680T	M6 X 80	50
CBNXM820	CBNXM820T	M8 X 20	25
CBNXM825	CBNXM825T	M8 X 25	25
CBNXM830	CBNXM830T	M8 X 30	25
CBNXM840	CBNXM840T	M8 X 40	25
CBNXM850	CBNXM850T	M8 X 50	25
CBNXM865	CBNXM865T	M8 X 65	25
CBNXM870	CBNXM870T	M8 X 70	25
CBNXM875	CBNXM875T	M8 X 75	25
CBNXM890	CBNXM890T	M8 X 90	25
CBNXM8100	CBNXM8100T	M8 X 100	25
CBNXM8130	CBNXM8130T	M8 X 110	25
CBNXM8130	CBNXM8130T	M8 X 130	25
CBNXM8140	CBNXM8140T	M8 X 140	25
CBNXM8150	CBNXM8150T	M8 X 150	25
CBNXM1040	CBNXM1040T	M10 X 40	25
CBNXM1050	CBNXM1050T	M10 X 50	25
CBNXM1060	CBNXM1060T	M10 X 60	25
CBNXM1065	CBNXM1065T	M10 X 65	25
CBNXM1070	CBNXM1070T	M10 X 70	25
CBNXM1075	CBNXM1075T	M10 X 75	25
CBNXM1080	CBNXM1080T	M10 X 80	25
CBNXM1090	CBNXM1090T	M10 X 90	25

PART #	PART #	SIZE	PACK QTY
CBNXM10100	CBNXM10100T	M10 X 100	25
CBNXM10110	CBNXM10110T	M10 X 110	25
CBNXM10120	CBNXM10120T	M10 X 120	25
CBNXM10130	CBNXM10130T	M10 X 130	25
CBNXM10140	CBNXM10140T	M10 X 140	25
CBNXM10150	CBNXM10150T	M10 X 150	25
CBNXM10160	CBNXM10160T	M10 X 160	25
CBNXM10180	CBNXM10180T	M10 X 180	10
CBNXM10190	CBNXM10190T	M10 X 190	10
CBNXM10200	CBNXM10200T	M10 X 200	10
CBNXM10220	CBNXM10220T	M10 X 220	10
CBNXM10240	CBNXM10240T	M10 X 240	10
CBNXM10260	CBNXM10260T	M10 X 260	10
CBNXM10280	CBNXM10280T	M10 X 280	10
CBNXM10300	CBNXM10300T	M10 X 300	10
CBNXM1240	CBNXM1240T	M12 X 40	25
CBNXM1250	CBNXM1250T	M12 X 50	25
CBNXM1260	CBNXM1260T	M12 X 60	25
CBNXM1265	CBNXM1265T	M12 X 65	25
CBNXM1275	CBNXM1275T	M12 X 75	25
CBNXM1280	CBNXM1280T	M12 X 80	25
CBNXM1290	CBNXM1290T	M12 X 90	25
CBNXM12100	CBNXM12100T	M12 X 100	25
CBNXM12110	CBNXM12110T	M12 X 110	25
CBNXM12120	CBNXM12120T	M12 X 120	25
CBNXM12130	CBNXM12130T	M12 X 130	25
CBNXM12140	CBNXM12140T	M12 X 140	25
CBNXM12150	CBNXM12150T	M12 X 150	25
CBNXM12160	CBNXM12160T	M12 X 160	10

1 BOLTS, NUTS, WASHERS & THREADED ROD

COACH BOLT & NUT

STAINLESS STEEL T304 STAINLESS STEEL T316

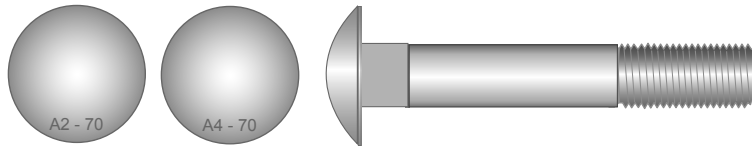

PART #	PART #	SIZE	PACK QTY
CBNXM12170	CBNXM12170T	M12 X 170	10
CBNXM12180	CBNXM12180T	M12 X 180	10
CBNXM12200	CBNXM12200T	M12 X 200	10
CBNXM12220	CBNXM12220T	M12 X 220	5
CBNXM12240	CBNXM12240T	M12 X 240	5
CBNXM12260	CBNXM12260T	M12 X 260	5
CBNXM12280	CBNXM12280T	M12 X 280	5
CBNXM12300	CBNXM12300T	M12 X 300	5
CBNXM1650	CBNXM1650T	M16 X 50	10
CBNXM1665	CBNXM1665T	M16 X 65	10
CBNXM1690	CBNXM1690T	M16 X 90	10
CBNXM16100	CBNXM16100T	M16 X 100	10
CBNXM16110	CBNXM16110T	M16 X 110	10
CBNXM16130	CBNXM16130T	M16 X 130	10
CBNXM16150	CBNXM16150T	M16 X 150	10
CBNXM16180	CBNXM16180T	M16 X 180	10
CBNXM16200	CBNXM16200T	M16 X 200	10
CBNXM16220	CBNXM16220T	M16 X 220	5
CBNXM16240	CBNXM16240T	M16 X 240	5
CBNXM16260	CBNXM16260T	M16 X 260	5
CBNXM16280	CBNXM16280T	M16 X 280	5
CBNXM16300	CBNXM16300T	M16 X 300	5
CBNXM20130	CBNXM20130T	M20 X 130	5
CBNXM20180	CBNXM20180T	M20 X 180	5
CBNXM20200	CBNXM20200T	M20 X 200	5

COACH SCREWS

GALVANISED CLASS 4.6

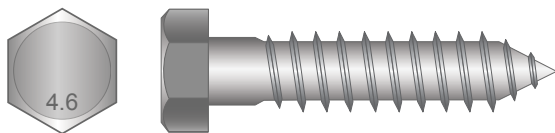

PART #	SIZE	PACK QTY
CSM640G	6mm X 40	150
CSM650G	6mm X 50	150
CSM665G	6mm X 65	150
CSM675G	6mm X 75	125
CSM690G	6mm X 90	100
CSM6100G	6mm X 100	100
CSM840G	8mm X 40	75
CSM850G	8mm X 50	75
CSM865G	8mm X 65	75
CSM875G	8mm X 75	75
CSM890G	8mm X 90	50
CSM8100G	8mm X 100	50
CSM1040G	10mm X 40	75
CSM1050G	10mm X 50	75
CSM1065G	10mm X 65	50
CSM1075G	10mm X 75	50
CSM1090G	10mm X 90	50
CSM10100G	10mm X 100	50
CSM10120G	10mm X 120	50
CSM10130G	10mm X 130	50
CSM10150G	10mm X 150	50
CSM10160G	10mm X 160	25

PART #	SIZE	PACK QTY
CSM10180G	10mm X 180	25
CSM1240G	12mm X 40	50
CSM1250G	12mm X 50	50
CSM1265G	12mm X 65	50
CSM1275G	12mm X 75	25
CSM1290G	12mm X 90	25
CSM12100G	12mm X 100	25
CSM12120G	12mm X 120	25
CSM12130G	12mm X 130	25
CSM12150G	12mm X 150	25
CSM12180G	12mm X 180	25
CSM12200G	12mm X 200	25
CSM12240G	12mm X 240	20
CSM12260G	12mm X 260	20
CSM12300G	12mm X 300	20
CSM1675G	16mm X 75	10
CSM16100G	16mm X 100	10
CSM16200G	16mm X 200	10
CSM16260G	16mm X 260	10
CSM20150G	20mm X 150	5
CSM20200G	20mm X 200	5

1 BOLTS, NUTS, WASHERS & THREADED ROD

COACH SCREWS

STAINLESS STEEL T304 STAINLESS STEEL T316

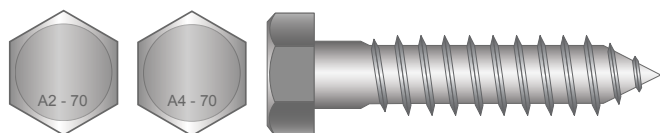

PART #	PART #	SIZE	PACK QTY
CSXM640	CSXM640T	6mm X 40	50
CSXM650	CSXM650T	6mm X 50	50
CSXM665	CSXM665T	6mm X 65	50
CSXM675	CSXM675T	6mm X 75	50
CSXM680	CSXM680T	6mm X 80	50
CSXM690	CSXM690T	6mm X 90	50
CSXM6100	CSXM6100T	6mm X 100	50
CSXM6130	CSXM6130T	6mm X 130	100
CSXM830	CSXM830T	8mm X 30	25
CSXM840	CSXM840T	8mm X 40	25
CSXM850	CSXM850T	8mm X 50	25
CSXM860	CSXM860T	8mm X 60	25
CSXM865	CSXM865T	8mm X 65	25
CSXM875	CSXM875T	8mm X 75	25
CSXM880	CSXM880T	8mm X 80	25
CSXM8100	CSXM8100T	8mm X 100	25
CSXM8120	CSXM8120T	8mm X 120	25
CSXM1040	CSXM1040T	10mm X 40	25
CSXM1050	CSXM1050T	10mm X 50	25
CSXM1065	CSXM1065T	10mm X 65	25
CSXM1070	CSXM1070T	10mm X 70	25
CSXM1075	CSXM1075T	10mm X 75	25
CSXM1080	CSXM1080T	10mm X 80	25
CSXM1090	CSXM1090T	10mm X 90	25
CSXM10100	CSXM10100T	10mm X 100	25
CSXM10120	CSXM10120T	10mm X 120	25
CSXM10130	CSXM10130T	10mm X 130	25
CSXM10150	CSXM10150T	10mm X 150	25
CSXM10180	CSXM10180T	10mm X 180	25
CSXM1250	CSXM1250T	12mm X 50	25

PART #	PART #	SIZE	PACK QTY
CSXM1265	CSXM1265T	12mm X 65	25
CSXM1270	CSXM1270T	12mm X 70	25
CSXM1275	CSXM1275T	12mm X 75	25
CSXM1280	CSXM1280T	12mm X 80	25
CSXM1290	CSXM1290T	12mm X 90	25
CSXM12100	CSXM12100T	12mm X 100	25
CSXM12120	CSXM12120T	12mm X 120	25
CSXM12130	CSXM12130T	12mm X 130	25
CSXM12150	CSXM12150T	12mm X 150	25
	CSXM12160T	12mm X 160	25
CSXM12180	CSXM12180T	12mm X 180	10
CSXM12200	CSXM12200T	12mm X 200	10
	CSXM12220T	12mm X 220	10
	CSXM12250T	12mm X 250	5
	CSXM12280T	12mm X 280	5
	CSXM12300T	12mm X 300	5
	CSXmm1675T	16mmx 75	5
	CSXM16100T	16mm x 100	5
	CSXM16120T	16mm x 12	5
	CSXM16150T	16mm x 150	5
	CSXM16180T	16mm x 180	5
	CSXM16200T	16mm x 200	5
	CSXM16240T	16mm x 240	5
	CSXM16350T	16mm x 350	5

SET SCREWS

ZINC PLATED CLASS 4.6

Set Screw is the industry term
for a fully threaded bolt
Nuts sold separately

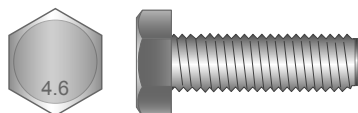

PART #	SIZE	PACK QTY
SSM450Z	M4 X 50	200
SSM510Z	M5 X 10	200
SSM512Z	M5 X 12	200
SSM520Z	M5 X 20	200
SSM525Z	M5 X 25	200
SSM530Z	M5 X 30	150
SSM612Z	M6 X 12	200
SSM616Z	M6 X 16	200
SSM620Z	M6 X 20	200
SSM625Z	M6 X 25	200
SSM630Z	M6 X 30	150
SSM635Z	M6 X 35	150
SSM640Z	M6 X 40	150
SSM650Z	M6 X 50	150
SSM665Z	M6 X 65	100
SSM812Z	M8 X 12	125
SSM816Z	M8 X 16	125
SSM820Z	M8 X 20	100
SSM825Z	M8 X 25	100
SSM830Z	M8 X 30	75
SSM835Z	M8 X 35	75
SSM840Z	M8 X 40	75
SSM845Z	M8 X 45	50
SSM850Z	M8 X 50	50
SSM865Z	M8 X 65	50
SSM875Z	M8 X 75	50
SSM1012Z	M10 X 12	100
SSM1016Z	M10 X 16	100
SSM1020Z	M10 X 20	100
SSM1025Z	M10 X 25	100

PART #	SIZE	PACK QTY
SSM1030Z	M10 X 30	100
SSM1035Z	M10 X 35	75
SSM1040Z	M10 X 40	75
SSM1040Z	M10 X 45	75
SSM1050Z	M10 X 50	75
SSM1055Z	M10 X 55	50
SSM1060Z	M10 X 60	50
SSM1065Z	M10 X 65	50
SSM1075Z	M10 X 75	50
SSM1090Z	M10 X 90	50
SSM10100Z	M10 X 100	50
SSM1220Z	M12 X 20	75
SSM1225Z	M12 X 25	75
SSM1230Z	M12 X 30	75
SSM1235Z	M12 X 35	50
SSM1240Z	M12 X 40	50
SSM1245Z	M12 X 45	50
SSM1250Z	M12 X 50	50
SSM1260Z	M12 X 60	25
SM1265Z	M12 X 65	25
SSM1275Z	M12 X 75	25
SSM12100Z	M12 X 100	25
SSM1625Z	M16 X 25	25
SSM1630Z	M16 X 30	25
SSM1635Z	M16 X 35	25
SSM1640Z	M16 X 40	25
SSM1650Z	M16 X 50	25
SSM1675Z	M16 X 75	25

1 BOLTS, NUTS, WASHERS & THREADED ROD

SET SCREWS

ZINC PLATED CLASS 8.8

Set Screw is the industry term
for a fully threaded bolt
Nuts sold separately

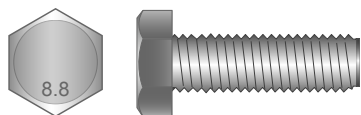

PART #	SIZE	PACK QTY
SSHM612Z	M6 X 12	200
SSHM616Z	M6 X 16	200
SSHM620Z	M6 X 20	200
SSHM625Z	M6 X 25	200
SSHM630Z	M6 X 30	200
SSHM635Z	M6 X 35	200
SSHM640Z	M6 X 40	200
SSHM645Z	M6 X 45	100
SSHM650Z	M6 X 50	100
SSHM812Z	M8 X 12	100
SSHM816Z	M8 X 16	100
SSHM820Z	M8 X 20	100
SSHM825Z	M8 X 25	100
SSHM830Z	M8 X 30	75
SSHM835Z	M8 X 35	75
SSHM840Z	M8 X 40	75
SSHM845Z	M8 X 45	75
SSHM850Z	M8 X 50	50
SSHM890Z	M8 X 90	50
SSHM1016Z	M10 X 16	100
SSHM1020Z	M10 X 20	100
SSHM1025Z	M10 X 25	100
SSHM1030Z	M10 X 30	100
SSHM1035Z	M10 X 35	100
SSHM1040Z	M10 X 40	75
SSHM1045Z	M10 X 45	75
SSHM1050Z	M10 X 50	75
SSHM1055Z	M10 X 55	75
SSHM1060Z	M10 X 60	50
SSHM1065Z	M10 X 65	50
SSHM10100Z	M10 X 100	25
SSHM1220Z	M12 X 20	75

PART #	SIZE	PACK QTY
SSHM1225Z	M12 X 25	75
SSHM1230Z	M12 X 30	75
SSHM1235Z	M12 X 35	50
SSHM1240Z	M12 X 40	50
SSHM1245Z	M12 X 45	50
SSHM1250Z	M12 X 50	25
SSHM1260Z	M12 X 60	25
SSHM1290Z	M12 X 90	25
SSHM12100Z	M12 X 100	25
SSHM1440Z	M14 X 40	25
SSHM1625Z	M16 X 25	25
SSHM1630Z	M16 X 30	25
SSHM1635Z	M16 X 35	25
SSHM1640Z	M16 X 40	25
SSHM1650Z	M16 X 50	25

SET SCREWS

ZINC PLATED CLASS 8.8 METRIC FINE

PART #	SIZE	PITCH	PACK QTY
SSMF820Z	M8 X 20	1.00	100
SSMF825Z	M8 X 25	1.00	100
SSMF835Z	M8 X 35	1.00	100
SSMF840Z	M8 X 40	1.00	100
SSMF1030Z	M10 X 30	1.25	100
SSMF1040Z	M10 X 40	1.25	100
SSMF1050Z	M10 X 50	1.25	100
SSMF1225Z	M12 X 25	1.25	100
SSMF1235Z	M12 X 35	1.25	100
SSMF1240Z	M12 X 40	1.25	100

SET SCREWS

STAINLESS STEEL T304 STAINLESS STEEL T316

Set Screw is the industry term for a fully threaded bolt
Nuts sold separately

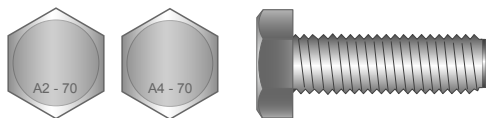

PART #	PART #	SIZE	PACK QTY
SSXM48	SSXM48T	M4 X 8	200
SSXM420	SSXM420T	M4 X 20	200
SSXM425	SSXM425T	M4 X 25	200
SSXM430	SSXM430T	M4 X 30	200
SSXM435	SSXM435T	M4 X 35	200
SSXM58	SSXM58T	M5 X 8	200
SSXM510	SSXM510T	M5 X 10	200
SSXM512	SSXM512T	M5 X 12	200
SSXM516	SSXM516T	M5 X 16	200
SSXM520	SSXM520T	M5 X 20	200
SSXM525	SSXM525T	M5 X 25	200
SSXM530	SSXM530T	M5 X 30	100
SSXM540	SSXM540T	M5 X 40	100
SSXM550	SSXM550T	M5 X 50	50
SSXM610	SSXM610T	M6 X 10	200
SSXM612	SSXM612T	M6 X 12	200
SSXM616	SSXM616T	M6 X 16	200
SSXM620	SSXM620T	M6 X 20	200
SSXM625	SSXM625T	M6 X 25	200
SSXM630	SSXM630T	M6 X 30	200
SSXM635	SSXM635T	M6 X 35	200
SSXM640	SSXM640T	M6 X 40	200
SSXM645	SSXM645T	M6 X 45	100
SSXM650	SSXM650T	M6 X 50	100
SSXM660	SSXM660T	M6 X 60	100
SSXM665	SSXM665T	M6 X 65	100
SSXM670	SSXM670T	M6 X 70	100
SSXM675	SSXM675T	M6 X 75	100
SSXM812	SSXM812T	M8 X 12	100
SSXM816	SSXM816T	M8 X 16	100
SSXM820	SSXM820T	M8 X 20	100

PART #	PART #	SIZE	PACK QTY
SSXM825	SSXM825T	M8 X 25	100
SSXM830	SSXM830T	M8 X 30	100
SSXM835	SSXM835T	M8 X 35	100
SSXM840	SSXM840T	M8 X 40	100
SSXM845	SSXM845T	M8 X 45	100
SSXM850	SSXM850T	M8 X 50	100
SSXM855	SSXM855T	M8 X 55	100
SSXM860	SSXM860T	M8 X 60	100
SSXM870	SSXM870T	M8 X 70	100
SSXM880	SSXM880T	M8 X 80	100
SSXM890	SSXM890T	M8 X 90	100
SSXM1016	SSXM1016T	M10 X 16	100
SSXM1020	SSXM1020T	M10 X 20	100
SSXM1025	SSXM1025T	M10 X 25	100
SSXM1030	SSXM1030T	M10 X 30	100
SSXM1035	SSXM1035T	M10 X 35	100
SSXM1045	SSXM1045T	M10 X 45	100
SSXM1040	SSXM1040T	M10 X 40	100
SSXM1050	SSXM1050T	M10 X 50	100
SSXM1055	SSXM1055T	M10 X 55	50
SSXM1065	SSXM1065T	M10 X 65	50
SSXM1080	SSXM1080T	M10 X 80	50
SSXM1220	SSXM1220T	M12 X 20	100
SSXM1225	SSXM1225T	M12 X 25	50
SSXM1230	SSXM1230T	M12 X 30	100
SSXM1235	SSXM1235T	M12 X 35	100
SSXM1240	SSXM1240T	M12 X 40	100
SSXM1245	SSXM1245T	M12 X 45	50
SSXM1250	SSXM1250T	M12 X 50	50
SSXM1255	SSXM1255T	M12 X 55	50

1 BOLTS, NUTS, WASHERS & THREADED ROD

SET SCREWS

STAINLESS STEEL T304 STAINLESS STEEL T316

Set Screw is the industry term
for a fully threaded bolt
Nuts sold separately

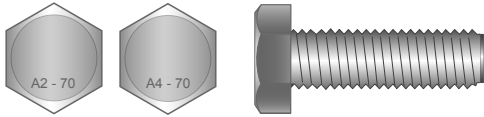

PART #	PART#	SIZE	PACK QTY
SSXM1260	SSXM1260T	M12 X 60	50
SSXM1265	SSXM1265T	M12 X 65	50
SSXM1270	SSXM1270T	M12 X 70	50
SSXM1275	SSXM1275T	M12 X 75	50
SSXM1280T	SSXM1280T	M12 X 80	25
SSXM1635	SSXM1635T	M16 X 35	50
SSXM1640	SSXM1640T	M16 X 40	50
SSXM1645	SSXM1645T	M16 X 45	50
SSXM1650	SSXM1650T	M16 X 50	25
SSXM1660	SSXM1660T	M16 X 60	25
SSXM1670	SSXM1670T	M16 X 70	25
SSXM1675	SSXM1675T	M16 X 75	25
SSXM2045	SSXM2045T	M20 X 45	5
SSXM2050	SSXM2050T	M20 X 50	5
SSXM2055	SSXM2055T	M20 X 55	5
SSXM2060	SSXM2060T	M20 X 60	5
SSXM2450	SSXM2450T	M24 X 50	5

SET SCREWS

STAINLESS STEEL T304 UNC

STAINLESS STEEL T316 UNC

Set Screw is the industry term for a fully threaded bolt
Nuts sold separately

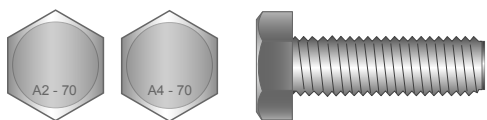

PART #	PART #	SIZE	PACK QTY
SSX1412	SSX1412T	1/4 X 1/2"	100
SSX1458	SSX1458T	1/4 X 5/8"	100
SSX1434	SSX1434T	1/4 X 3/4"	100
SSX141	SSX141T	1/4 X 1"	100
SSX14114	SSX14114T	1/4 X 1 1/4"	100
SSX14112	SSX14112T	1/4 X 1 1/2"	100
SSX142	SSX142T	1/4 X 2"	100
SSX14212	SSX14212T	1/4 X 2 1/2"	50
SSX143	SSX143T	1/4 X 3"	50
SSX51612	SSX51612T	5/16 X 1/2"	100
SSX51658	SSX51658T	5/16 X 5/8"	100
SSX51634	SSX51634T	5/16 X 3/4"	100
SSX5161	SSX5161T	5/16 X 1"	100
SSX516114	SSX516114T	5/16 X 1 1/4"	100
SSX516112	SSX516112T	5/16 X 1 1/2"	100
SSX5162	SSX5162T	5/16 X 2"	100
SSX516212	SSX516212T	5/16 X 2 1/2"	50
SSX5163	SSX5163T	5/16 X 3"	50
SSX5164	SSX5164T	5/16 X 4"	50
SSX3812	SSX3812T	3/8 X 1/2"	100
SSX3858	SSX3858T	3/8 X 5/8"	100
SSX3834	SSX3834T	3/8 X 3/4"	100
SSX381	SSX381T	3/8 X 1"	100
SSX38114	SSX38114T	3/8 X 1 1/4"	100
SSX38112	SSX38112T	3/8 X 1 1/2"	100
SSX38134	SSX38134T	3/8 X 1 3/4"	100
SSX382	SSX382T	3/8 X 2"	100
SSX38212	SSX38212T	3/8 X 2 1/2"	50
SSX383	SSX383T	3/8 X 3"	50
SSX38312	SSX38312T	3/8 X 3 1/2"	50
SSX384	SSX384T	3/8 X 4"	50

PART #	PART #	SIZE	PACK QTY
SSX121	SSX121T	1/2 X 1"	100
SSX12Z114	SSX12114T	1/2 X 1 1/4"	100
SSX12112	SSX12112T	1/2 X 1 1/2"	50
SSX122	SSX122T	1/2 X 2"	50
SSX12212	SSX12212T	1/2 X 2 1/2"	50
SSX123	SSX123T	1/2 X 3"	50
SSX12312	SSX12312T	1/2 X 3 1/2"	50
SSX124	SSX124T	1/2 X 4"	25
SSX581	SSX581T	5/8 X 1"	25
SSX58112	SSX58112T	5/8 X 1 1/2"	25
SSX582	SSX582T	5/8 X 2"	25
SSX58212	SSX58212T	5/8 X 2 1/2"	25
SSX583	SSX583T	5/8 X 3"	25
SSX584	SSX584T	5/8 X 4"	25
SSX34112	SSX34112T	3/4 X 1 1/2"	25
SSX34134	SSX34134T	3/4 X 1 3/4"	25
SSX342	SSX342T	3/4 X 2"	25
SSX34212	SSX34212T	3/4 X 2 1/2"	25
SSX343	SSX343T	3/4 X 3"	20
SSX344	SSX344T	3/4 X 4"	10
SSX782	SSX782T	7/8 X 2"	10
SSX78212	SSX78212T	7/8 X 2 1/2"	10
SSX783	SSX783T	7/8 X 3"	10
SSX12	SSX12T	1 X 2"	10
SSX1212	SSX1212T	1 X 2 1/2"	10
SSX13	SSX13T	1 X 3"	10
SSX1312	SSX1312T	1 X 3 1/2"	10

1 BOLTS, NUTS, WASHERS & THREADED ROD

CLOSED EYE BOLTS

GALVANISED

* Sizes outside of range available upon request
Subject to availability

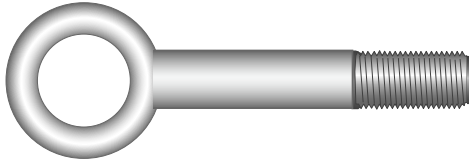

PART #	SIZE	PACK QTY
BEYEM12150G	M12 X 150	10
BEYEM12180G	M12 X 180	10
BEYEM12200G	M12 X 200	10
BEYEM12250G	M12 X 250	10

JOINT CONNECTOR BOLTS

ZINC CHROMATE & BRASS PLATE STAINLESS STEEL T304

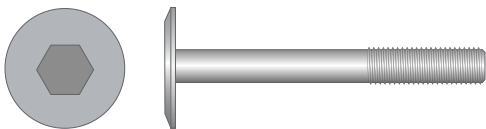

PART #	FINISH	SIZE	PACK QTY
JCBM650ZC	Z/C	M6 X 50	100
JCBM660ZC		M6 X 60	100
JCBM670ZC		M6 X 70	100
JCBM650BP	BRASS PLATE	M6 X 50	100
JCBM660BP		M6 X 60	100
JCBM670BP		M6 X 70	100
JCBM680BP		M6 X 80	100
JCBM6100BP		M6 X 100	100
NBARM620Z	BRASS PLATE	M6 X 20 BARREL NUT	100

PART #	SIZE	PACK QTY
JCBXM625	M6 X 25	100
JCBXM635	M6 X 35	100
JCBXM640	M6 X 40	100
JCBXM650	M6 X 50	100
JCBXM660	M6 X 60	100
JCBXM660	M6 X 70	100

* Sizes outside of range available upon request
- Subject to availability

COMPONENT HEADS/BARREL NUTS

STAINLESS STEEL T316

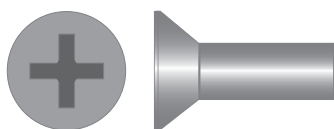

PART #	SIZE	PACK QTY
CFSACHX65	6.5mm COUNTERSUNK HEAD FOR SLEEVE ANCHORS (5mm THREAD)	1
CFSACHX8	8mm COUNTERSUNK HEAD FOR SLEEVE ANCHORS (6mm THREAD)	1
CFSACHX10	10mm COUNTERSUNK HEAD FOR SLEEVE ANCHORS (8mm THREAD)	1

GUTTER BOLTS & NUTS

ZINC PLATED

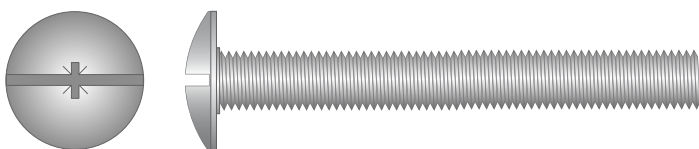

PART #	SIZE	PACK QTY
GBNM510ZJ	M5 X 10	100
GBNM512ZJ	M5 X 12	100
GBNM516ZJ	M5 X 16	100
GBNM520ZJ	M5 X 20	100
GBNM525ZJ	M5 X 25	100
GBNM530ZJ	M5 X 30	100
GBNM540ZJ	M5 X 40	100
GBNM550ZJ	M5 X 50	100
GBNM560ZJ	M5 X 60	50
GBNM580ZJ	M5 X 80	50
GBNM612ZJ	M6 X 12	100

PART #	SIZE	PACK QTY
GBNM616ZJ	M6 X 16	100
GBNM620ZJ	M6 X 20	100
GBNM625ZJ	M6 X 25	100
GBNM630ZJ	M6 X 30	100
GBNM635ZJ	M6 X 35	100
GBNM640ZJ	M6 X 40	50
GBNM645ZJ	M6 X 45	50
GBNM650ZJ	M6 X 50	50
GBNM660ZJ	M6 X 60	50
GBNM680ZJ	M6 X 80	25

1 BOLTS, NUTS, WASHERS & THREADED ROD

THREADED ROD

ZINC PLATED CLASS 4.6 **GALVANISED CLASS 4.6**

* Stud cutting service available. Contact your Account Manager for more information.

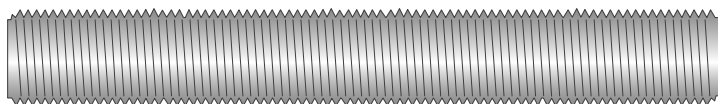

PART #	PART #	SIZE
TRM4Z		M4 X 1 METRE
TRM5Z		M5 X 1 METRE
TRM6Z		M6 X 1 METRE
TRM62Z		M6 X 2 METRE
TRM8Z	TRM8G	M8 X 1 METRE
TRM82Z		M8 X 2 METRE
TRM10Z	TRM10G	M10 X 1 METRE
TRM102Z	TRM102G	M10 X 2 METRE
TRM103Z		M10 X 3 METRE
TRM12Z	TRM12G	M12 X 1 METRE

PART #	PART #	SIZE
TRM122Z	TRM122G	M12 X 2 METRE
TRM123Z		M12 X 3 METRE
TRM14Z		M14 X 1 METRE
TRM16Z	TRM16G	M16 X 1 METRE
TRM162Z	TRM162G	M16 X 2 METRE
	TRM163G	M16 X 3 METRE
TRM20Z	TRM20G	M20 X 1 METRE
	TRM203G	M20 X 3 METRE
TRM24Z	TRM24G	M24 X 1 METRE
TRM30Z	TRM30G	M30 X 1 METRE

ZINC PLATED CLASS 8.8 **GALVANISED CLASS 8.8**

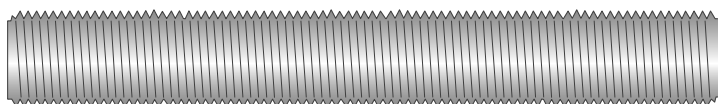

PART #	PART #	SIZE
TRHM6Z		M6 X 1 METRE
TRHM8Z		M8 X 1 METRE
TRHM10Z		M10 X 1 METRE
TRHM12Z	TRHM12G	M12 X 1 METRE
	TRHM123G	M12 X 3 METRE
TRHM16Z	TRHM16HG	M16 X 1 METRE
	TRHM163G	M16 X 3 METRE
TRHM20Z	TRHM20G	M20 X 1 METRE
	TRHM203G	M20 X 3 METRE
TRHM24Z	TRHM24G	M24 X 1 METRE

PART #	PART #	SIZE
	TRHM243G	M24 X 3 METRE
TRHM30Z	TRHM30HG	M30 X 1 METRE
	TRHM303G	M30 X 3 METRE
	TRHM36G	M36 X 1 METRE
	TRHM363G	M36 X 3 METRE

THREADED ROD

STAINLESS STEEL T304 STAINLESS STEEL T316

* Stud cutting service available. Contact your Account Manager for more information.

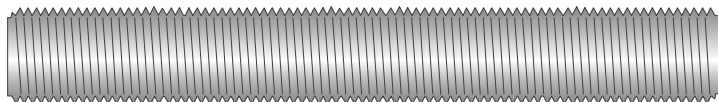

PART #	PART #	SIZE
	TRXM3T	M3 X 1 METRE
TRXM4	TRXM4T	M4 X 1 METRE
TRXM5	TRXM5T	M5 X 1 METRE
TRXM6	TRXM6T	M6 X 1 METRE
TRXM8	TRXM8T	M8 X 1 METRE
TRXM10	TRXM10T	M10 X 1 METRE
TRXM12	TRXM12T	M12 X 1 METRE

PART #	PART #	SIZE
	TRXM122T	M12 X 2 METRE
TRXM16	TRXM16T	M16 X 1 METRE
	TRXM162T	M16 X 2 METRE
TRXM20	TRXM20T	M20 X 1 METRE
	TRXM202T	M20 X 2 METRE
TRXM24	TRXM24T	M24 X 1 METRE
	TRXM30T	M30 X 1 METRE

THREADED ROD IMPERIAL

STAINLESS STEEL T304 UNC/UNF

STAINLESS STEEL T316 UNF/UNC

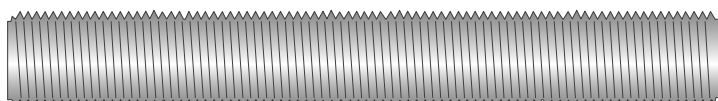

PART #	PART #	SIZE
TRX1	TRX1T	1" X 3FT
TRX12	TRX12T	1/2" X 3FT
TRX14	TRX14T	1/4" X 3FT
TRX316	TRX316T	3/16" X 3FT
TRX34	TRX34T	3/4" X 3FT
TRX38	TRX38T	3/8" X 3FT
TRX516	TRX516T	5/16" X 3FT
TRX58	TRX58T	5/8" X 3 FT

1 BOLTS, NUTS, WASHERS & THREADED ROD

COUPLING NUTS

ZINC PLATED GALVANISED STAINLESS STEEL T316



PART #	PART #	PART #	SIZE	PACK QTY
NCM6Z		NCXM6T	M6	EACH
NCM8Z			M8	EACH
NCM10Z	NCM10G	NCXM10T	M10	EACH
NCM12Z	NCM12G	NCXM12T	M12	EACH
NCM16Z	NCM16G	NCXM16T	M16	EACH
NCM20Z	NCM20G	NCXM20T	M20	EACH
NCM24Z	NCM24G		M24	EACH

HEX FULL NUTS

BLACK ZINC PLATED GALVANISED



SIZE	PART #	PACK QTY	PART #	PART #	PACK QTY
M2			NHFSM2Z		200
M2.5			NHFSM25Z		200
M3			NHFSM3Z		200
M4			NHFSM4Z		200
M5			NHFSM5Z		200
M6	NHFSM6B	100	NHFSM6Z		200
M8	NHFSM8B	100	NHFSM8Z	NHFSM8G	200
M10	NHFSM10B	100	NHFSM10Z	NHFSM10G	100
M12	NHFSM12B	100	NHFSM12Z	NHFSM12G	100
M14			NHFSM14Z		100
M16	NHFSM16B	100	NHFSM16Z	NHFSM16G	100
M18	NHFSM18B	100	NHFSM18Z		100
M20	NHFSM20B	100	NHFSM20Z	NHFSM20G	100
M22	NHFSM22B	25		NHFSM22G	50
M24	NHFSM24B	25	NHFSM24Z	NHFSM24G	25
M30	NHFSM30B	25	NHFSM30Z	NHFSM30G	25
M33				NHFSM33G	EACH
M36	NHFSM36B	EACH		NHFSM36G	EACH
M39				NHFSM39G	EACH
M42				NHFSM42G	EACH
M48	NHFSM48B	EACH		NHFSM48G	EACH

1 BOLTS, NUTS, WASHERS & THREADED ROD

HEX FULL NUTS

STAINLESS STEEL T304 STAINLESS STEEL T316



PART #	PART #	SIZE	PACK QTY
NHFXM2	NHFXM2T	M2	200
NHFXM3	NHFXM3T	M3	200
NHFXM4	NHFXM4T	M4	200
NHFXM5	NHFXM5T	M5	200
NHFXM6	NHFXM6T	M6	200
NHFXM8	NHFXM8T	M8	200
NHFXM10	NHFXM10T	M10	100
NHFXM12	NHFXM12T	M12	100
NHFXM14	NHFXM14T	M14	EACH
NHFXM16	NHFXM16T	M16	50
NHFXM20	NHFXM20T	M20	50
NHFXM24	NHFXM24T	M24	EACH
NHFXM27	NHFXM27T	M27	EACH
NHFXM30	NHFXM30T	M30	EACH

HEX FULL NUTS

BLACK METRIC FINE ZINC PLATED METRIC FINE



SIZE	PITCH	PART #	PART #	PACK QTY
M6	0.75		NHFSMF6Z	100
M8	1.0	NHFSMF8B	NHFSMF8Z	100
M10	1.25	NHFSMF10B	NHFSMF10Z	100
M12	1.25	NHFSMF12B	NHFSMF12Z	100
M14	1.5	NHFSMF14B	NHFSMF14Z	100
M16	1.5	NHFSMF16B	NHFSMF16Z	100
M18	1.5	NHFSMF18B	NHFSMF18Z	100
M20	1.5	NHFSMF20B	NHFSMF20Z	100
M24	2.0	NHFSMF24B		25

LOCK NUTS (HALF NUTS)

ZINC PLATED



SIZE	METRIC FINE PITCH	METRIC FINE PART #	METRIC COARSE PART #
M5	1.25	NHLSMF10Z	NHLSM5Z
M6			NHLSM6Z
M8			NHLSM10Z
M10			NHLSM10Z
M12			NHLSM12Z
M14		NHJSMF12Z	
M16	1.5	NHLSMF16Z	NHLSM16Z
M18	1.5	NHLSMF18Z	
M20	1.5	NHLSMF20Z	NHLSM20Z
M24	2.0	NHLSM24FZ	

TEE NUTS

ZINC PLATED

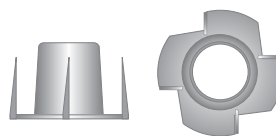

SIZE	PART #
1/4"	NT14Z
3/16"	NT316Z
3/8"	NT38Z
5/16"	NT516Z
M4	NTM4Z
M5 (15mm OD)	NTM5Z
M6 (18mm OD)	NTM618Z
M6 (20mm OD)	NTM620Z
M8 (19mm OD)	NTM819Z
M8 (22mm OD)	NTM822Z
M10	NTM10Z

LOCK NUTS (HALF NUTS)

STAINLESS STEEL T304 STAINLESS STEEL T316



SIZE	PART #	PART #	PACK QTY
M5	NHLXM5	NHLXM5T	100
M6	NHLXM6	NHLXM6T	100
M8	NHLXM8	NHLXM8T	100
M10	NHLXM10	NHLXM10T	100
M12	NHLXM12	NHLXM12T	100
M16	NHLXM16	NHLXM16T	50
M20	NHLXM20	NHLXM20T	25
M24	NHLXM24	NHLXM24T	25
M30	NHLXM30	NHLXM30T	25

1 BOLTS, NUTS, WASHERS & THREADED ROD

DOME NUTS

STAINLESS STEEL T304 STAINLESS STEEL T316 BRASS & NICKEL PLATE

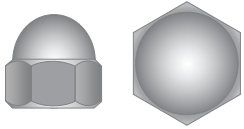

PART #	PART #	PART #	SIZE
	NDXM3T	NDM3	M3
NDXM4	NDXM4T	NDM4	M4
NDXM5	NDXM5T	NDM5	M5
NDXM6	NDXM6T	NDM6	M6
NDXM8	NDXM8T	NDM8	M8
NDXM10	NDXM10T	NDM10	M10
NDXM12	NDXM12T	NDM12	M12
NDXM16	NDXM16T	NDM16	M16
NDXM20	NDXM20T		M20
NDXM24	NDXM24T		M24

CONE LOCK NUTS

ZINC PLATED

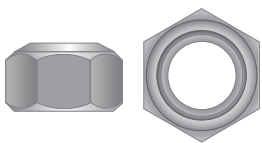

SIZE	PITCH		PART #	PACK QTY
M10			NCONEM10Z	100
M12			NCONEM12Z	100
M14			NCONE14Z	50
M16			NCONEM16Z	50
M16	1.5	METRIC FINE	NCONEMF16Z	50
M20			NCONE20Z	50
M20	1.5	METRIC FINE	NCONEMF20Z	50

CONE LOCK NUTS - IMPERIAL

ZINC PLATED

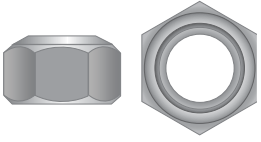

SIZE	UNC PART #	UNF PART #	PACK QTY
3/8"	NCONE38CZ	NCONE38FZ	100
5/16"	NCONE516CZ	NCONE516FZ	100
1/2"	NCONE12CZ	NCONE12FZ	100
5/8"	NCONE58CZ	NCONE58FZ	50
7/8"		NCONE78FZ	50
3/4"	NCONE34CZ	NCONE34FZ	25

1 BOLTS, NUTS, WASHERS & THREADED ROD

INSERT NUTS

ZINC PLATED

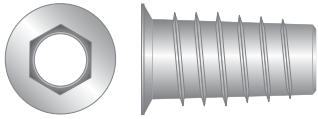

SIZE		PART #	PACK QTY
5/16 X 18	FLANGE	INSERT51618Z	200
5/32 X 10	FLANGE	INSERT532F	200
M6 X 13		INSERTM613	200
M6 X 13	FLANGE	INSERTM613D	200
M6 X 20		INSERTM620	200
M6 X 20	FLANGE	INSERTM620F	200
M8 X 13		INSERTM813	200
M8 X 20	FLANGE	INSERTM820	200

CAGE NUTS

ZINC CHROMATE

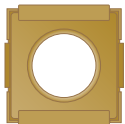

SIZE	PLATE SIZE	PART #	PACK QTY
M5		NCAGEM5ZC	100
M6	1.0mm	NCAGEM610ZC	100
M6	1.6mm	NCAGEM616ZC	100
M6	3.2mm	NCAGEM632ZC	100
M8		NCAGEM8ZC	100
M10		NCAGEM10ZC	100

NYLOC NUTS

STAINLESS STEEL T304 STAINLESS STEEL T316

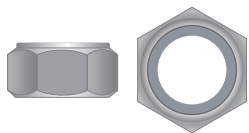

PART #	PART #	SIZE	PACK QTY
NYLXM25		M2.5	200
NYLXM3	NYLXM3T	M3	200
NYLXM4	NYLXM4T	M4	200
NYLXM5	NYLXM5T	M5	200
NYLXM6	NYLXM6T	M6	200
NYLXM8	NYLXM8T	M8	200
NYLXM10	NYLXM10T	M10	100
NYLXM12	NYLXM12T	M12	100
NYLXM14	NYLXM14T	M14	100
NYLXM16	NYLXM16T	M16	50
NYLXM20	NYLXM20T	M20	50
	NYLXM24T	M24	EACH
	NYLXM30T	M30	EACH

ZINC PLATED GALVANISED

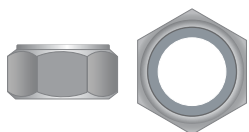

SIZE	PART #	PACK QTY	PART #	PACK QTY
M3	NYLM3Z	1000		
M4	NYLM4Z	200		
M5	NYLM5Z	200		
M6	NYLM6Z	200		
M8	NYLM8Z	200	NYLM8G	200
M10	NYLM10Z	100	NYLM10G	100
M12	NYLM12Z	100	NYLM12G	100
M14	NYLM14Z	100		
M16	NYLM16Z	50	NYLM16G	50
M20	NYLM20Z	50	NYLM20G	25
M24	NYLM24Z	50	NYLM24G	25

1 BOLTS, NUTS, WASHERS & THREADED ROD

IMPERIAL NYLOC AND HEX FULL NUTS

STAINLESS STEEL T304 STAINLESS STEEL T316

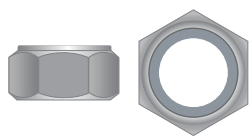

SIZE	PART #	PART #	PACK QTY
3/16" UNC	NYLX316	NYLX316T	100
1/4" UNC	NYLX14	NYLX14T	100
1/4" UNF	NYLX14F	NYLX14FT	100
5/16" UNC	NYLX516	NYLX516T	100
5/16" UNF	NYLX516F	NYLX516FT	100
3/8" UNC	NYLX38	NYLX38T	100
3/8" UNF	NYLX38F	NYLX38FT	100
7/16 UNC	NYLX716	NYLX716T	100
7/16 UNF	NYLX716F	NYLX716FT	100
1/2" UNC	NYLX12	NYLX12T	100
1/2" UNF	NYLX12F	NYLX12FT	100
1/2" BSW	NYLX12	NYLX12T	100
5/8" UNC	NYLX58	NYLX58T	50
3/4" UNC	NYLX34	NYLX34T	25
1" UNC	NYLX1	NYLX1T	25

SIZE	PART #	PART #	PACK QTY
1/8" UNC	NHFX18		100
5/32" UNC	NHFX532		100
3/16" UNC	NHFX316	NHFX316T	100
3/16" UNF	NHFX316F	NHFX316FT	100
1/4" UNC	NHFX14	NHFX14T	100
1/4" UNF	NHFX14F	NHFX14FT	100
5/16" UNC	NHFX516	NHFX516T	100
5/16" UNF	NHFX516F	NHFX516FT	100
3/8" UNC	NHFX38	NHFX38T	100
3/8" UNF	NHFX38F	NHFX38FT	100
1/2" UNC	NHFX12	NHFX12T	100
7/16" UNC	NHFX716	NHFX716T	100
1/2" UNF	NHFX12F	NHFX12FT	100
1/2" BSW	NHFX12	NHFX12T	100
5/8" UNC	NHFX58	NHFX58T	100
5/8" UNF	NHFX58F	NHFX58FT	100
3/4" UNC	NHFX34	NHFX34T	100
3/4" UNF	NHFX34F	NHFX34FT	100
7/8" UNC	NHFX78	NHFX78T	100
1" UNC	NHFX1	NHFX1T	100
1 1/4" UNC		NHFX114T	100
1 1/8" UNC		NHFX118T	100

HEX FULL NUTS IMPERIAL

BLACK ZINC PLATED

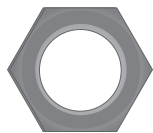

SIZE	UNF PART #	UNF PART #	UNC PART #	UNC PART #	PACK QTY
1/4"	NHFS14FB	NHFS14FZ	NHFS14B	NHFS14Z	150
5/16"	NHFS516FB	NHFS516FZ	NHFS516B	NHFS516Z	100
3/8"	NHFS38FB	NHFS38FZ	NHFS38B	NHFS38Z	100
7/16"	NHFS716FB	NHFS716FZ	NHFS716B	NHFS716Z	100
1/2"	NHFS12FB	NHFS12FZ	NHFS12B	NHFS12Z	100
9/16"	NHFS916FB	NHFS916FZ	NHFS916B	NHFS916Z	100
5/8"	NHFS58FB	NHFS58FZ	NHFS58B	NHFS58Z	100
3/4"	NHFS34FB		NHFS34B	NHFS34Z	50
7/8"	NHFS78FB		NHFS78B	NHFS78Z	50
1"			NHFS1B	NHFS1Z	50
1 1/8"	NHFS118FB		NHFS118B		25
1 1/4"	NHFS114FB		NHFS114B		25
1 1/2"	NHFS112FB		NHFS112B		15
2"			NHFS2B		10
2 1/4"			NHFS214B		10

WING NUTS

STAINLESS STEEL T304 STAINLESS STEEL T316 ZINC PLATED



SIZE	CODE	CODE	CODE	PACK QTY
1/4"	NWX14	NWX14T	NW14Z	200
3/16"	NWX316	NWX316T	NW316Z	200
3/8"	NWX38	NWX38T	NW38Z	200
5/16"	NWX516	NWX516T	NW516Z	200
1/2" UNC	NWX12	NWX12T		
M3		NWXM3T		
M4		NWXM4T	NWM4Z	200
M5		NWXM5T	NWM5Z	200
M6	NWXM6	NWXM6T	NWM6Z	200
M8	NWXM8	NWXM8T	NWM8Z	200
M10	NWXM10	NWXM10T	NWM10Z	200
M12	NWXM12	NWXM12T	NWM12Z	200

1 BOLTS, NUTS, WASHERS & THREADED ROD

ROUND WASHERS

ZINC PLATED

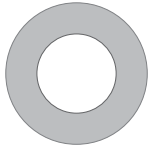

SIZE	PART #	PACK QTY
M3 X 7	WM37Z	200
M3 X 9	WM39Z	200
M3 X 9.5 X .9	WM395Z	200
M4 X 9	WM49Z	200
M4 X 11	WM411Z	200
M5 X 10	WM510Z	200
M5 X 12	WM512Z	200
M5 X 19	WM519Z	200
M5 X 32	WM532Z	200
M6 X 12.5	WM6125Z	200
M6 X 16 X 1.2	WM61612Z	200
M6 X 16 X 1.6	WM616Z	200
M6 X 19 X 1.2	WM61912Z	200
M6 X 19 X 1.6	WM61916Z	200
M6 X 19 X 3	WM6193Z	200
M6 X 22 X 1.2	WM622Z	200
M6 X 32	WM632Z	100
M8 X 16 X 1.2	WM81612Z	200
M8 X 16 X 1.6	WM816Z	200
M8 X 19 X 1.6	WM819Z	200
M8 X 21 X 1.6	WM821Z	200
M8 X 22 X 3	WM8223Z	100

SIZE	PART #	PACK QTY
M8 X 32	WM832Z	100
M10 X 21	WM1021Z	200
M10 X 24 X 1.6	WM1024Z	100
M10 X 24 X 2.5	WM102425Z	200
M10 X 25 X 3	WM10253Z	100
M10 X 32	WM1032Z	100
M12 X 24	WM1224Z	200
M12 X 28 X 1.6	WM1228Z	100
M12 X 28 X 3	WM12283Z	100
M12 X 32 X 1.6	WM1232Z	100
M12 X 32 X 3	WM12323Z	100
M14 X 32 X 1.6	WM1432Z	100
M14 X 32 X 3	WM143216Z	200
M16 X 30 X 1.6	WM1630Z	200
M16 X 32 X 1.6	WM1632Z	100
M16 X 34 X 3	WM16343Z	50
M20 X 37 X 1.6	WM2037Z	50
M20 X 37 X 2	WM20372Z	50
M20 X 39 X 3	WM20393Z	50
M24 X 44 X 3	WM24443Z	50
M32 X 44.5 X 3	WM324453Z	50
M33 X 67 X 3	WM33673Z	50

ROUND WASHERS

GALVANISED BLACK

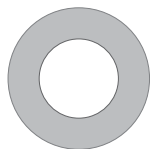

SIZE	PART #	PACK QTY	PART #	PACK QTY
M6 X 19 X 3	WM6G	100	WM61914B	200
M8 X 16 X 3	WM8163G	200		
M8 X 17			WM817B	200
M8 X 19 X 2.5	WM81925G	200		
M8 X 22 X 3	WM8G	100		
M8 X 42 X 3	WM8423G	50		
M10 X 21 X 1.6	WM102116G	200		
M10 X 25 X 3	WM10G	100	WM10253B	200
M10 X 30 X 3	WM10303G	100		
M12 X 24 X 1.6	WM12416G	100		
M12 X 28 X 3	WM12G	100	WM12283B	100
M12 X 32 X 3			WM12323B	100
M12 X 39 X 6	WM1239G	100		
M14 X 32 X 3			WM14323B	100
M16 X 30 X 1.6	WM163016G	100		
M16 X 34 X 3	WM16G	100	WM16343B	100
M16 X 38 X 3	WM16383G	50	WM16383B	100
M20 X 39 X 3	WM20G	50	WM20393B	100
M20 X 45 X 2.5			WM204525B	50
M24 X 44 X 3	WM24443G	50	WM24443B	50
M24 X 50 X 3	WM24G	50	WM24503B	50
M24 X 54 X 3	WM24543G	50	WM24543B	50
M24 X 65 X 6	WM24656G	50		
M27 X 55 X 3	WM27553G	50		
M27 X 60 X 3	WM27603G	50		
M30 X 60 X 3	WM30G	50	WM30603B	50
M32 X 44.5 X 3			WM324453B	50
M33 X 67 X 3	WM33673G	50	WM33673B	50
M33 X 67 X 6	WM33676G	50		
M36 X 72 X 3			WM3723B	50
M42 X 85 X 3	WM42853G	50	WM43853B	50
M45.11 X 85 X 3			WM45853B	50

1 BOLTS, NUTS, WASHERS & THREADED ROD

SQUARE WASHERS

GALVANISED STAINLESS STEEL T304 STAINLESS STEEL T316



SIZE	PART #	PACK QTY	PART #	PACK QTY	PART #	PACK QTY
M10 X 40 X 40 X 3	WQM10403G	50			WQXM1040T	50
M10 X 50 X 50 X 3	WQM10G	50			WQXM1050T	50
M12 X 40 X 40 X 3	WQM12403G	50				
M12 X 50 X 50 X 3	WQM12G	50	WQXM1250	50	WQXM1250T	50
M16 X 40 X 40 X 3	WQM16403	50				
M16 X 50 X 50 X 3	WQM16G	25	WQXM1650	50	WQXM1650T	50
M20 X 50 X 50 X 3	WQM20G	EACH			WQXM20T	50
M22 X 50 X 50 X 3	WQM22503G	EACH				
M30 X 60 X 60 X 3	WQM30603G	EACH				
M10 X 50 X 50 X 5					WQXM10505T	50
M12 X 40 X 40 X 6	WQM12406G	50				
M12 X 50 X 50 X 6	WQM12506	50				
M16 X 50 X 50 X 6	WQM16506G	EACH			WQXM16506T	50
M16 X 60 X 60 X 6	WQM16606G	EACH				
M16 X 80 X 80 X 5					WQXM16805T	25
M16 X 80 X 80 X 6	WQM16806G	EACH				
M20 X 60 X 60 X 6	WQM20606G	EACH				
M20 X 50 X 50 X 6	WQM20506G	EACH				
M24 X 80 X 80 X 6	WQM24806G	EACH				

Sizes outside of range available upon request. Subject to availability.

SPRING WASHERS

STAINLESS STEEL T304 STAINLESS STEEL T316 ZINC PLATED GALVANISED

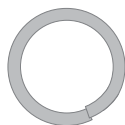

SIZE	PART #	PART #	PART #	PART #	PACK QTY
M3	WSPXM3	WSPXM3T	WSPM3Z		100
M4	WSPXM4	WSPXM4T	WSPM4Z		100
M5	WSPXM5	WSPXM5T	WSPM5Z		100
M6	WSPXM6	WSPXM6T	WSPM6Z	WSPM6G	200/100
M8	WSPXM8	WSPXM8T	WSPM8Z	WSPM8G	200
M10	WSPXM10	WSPXM10T	WSPM10Z	WSPM10G	100
M12	WSPXM12	WSPXM12T	WSPM12Z	WSPM12G	100
M14			WSPM14Z		100
M16	WSPXM16	WSPXM16T	WSPM16Z	WSPM16G	100
M18			WSPM18Z		100
M20	WSPXM20	WSPXM20T	WSPM20Z	WSPM20G	100
M24	WSPXM24	WSPXM24T	WSPM24Z	WSPM24G	100
M25				WSPM25G	100
M30	WSPXM30	WSPXM30T	WSPM30Z	WSPM30G	100
M36			WSPM36Z	WSPM36G	100

Sizes outside of range available upon request. Subject to availability.

1 BOLTS, NUTS, WASHERS & THREADED ROD

LOCK WASHERS

ZINC PLATED STAINLESS STEEL T304

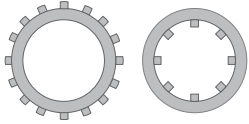

SIZE	EXTERNAL PART #	INTERNAL PART #	EXTERNAL PART #	INTERNAL PART #	PACK QTY
M3		WLXM3I	WLM3EZ	WLM3IZ	200
M4	WLXM4E	WLXM4I	WLM4EZ	WLM4IZ	200
M5	WLXM5E	WLXM5I	WLM5EZ	WLM5IZ	200
M5	WLXM6E	WLXM6I	WLM6EZ	WLM6IZ	200
M8	WLXM8E	WLXM8I	WLM8EZ	WLM8IZ	200
M10	WLXM10E	WLXM10I	WLM10EZ	WLM10IZ	100
M12	WLXM12E	WLXM12I	WLM12EZ	WLM12IZ	100

CUP WASHERS

BRASS

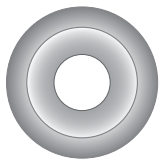

SIZE	FINISH	PART #	PACK QTY
NO 4	PLAIN	WC4	100
NO 4	NICKEL	WC4N	100
NO 4	ZINC	WC4Z	100
NO 6	PLAIN	WC6	100
NO 6	BMA	WC6F	100
NO 6	NICKEL	WC6N	100
NO 8	PLAIN	WC8	100
NO 8	BMA	WC8F	100
NO 8	NICKEL	WC8N	100
NO 10	BMA	WC10F	100
NO 10	NICKEL	WC10N	100
NO 12	NICKEL	WC12N	100

STAINLESS STEEL T304

SIZE	PART #	PACK QTY
NO 6	WCX6	100
NO 8	WCX8	100
NO 10	WCX10	100
NO 12	WCX12	100

1 BOLTS, NUTS, WASHERS & THREADED ROD

STARLOCK WASHERS

CAPPED & UNCAPPED



SIZE	PART #	PACK QTY
1/2 PLAIN	WST12	100
1/2 CAPPED	WST12C	100
1/4 PLAIN	WST14	100
1/4 CAPPED	WST14C	100
3/16 PLAIN	WST316	100
3/8 PLAIN	WST38	100
3/8 CAPPED	WST38C	100
5/16 PLAIN	WST516	100
5/16 CAPPED	WST516C	100
M3 PLAIN	WSTM3	100
M4 PLAIN	WSTM4	100
M5 PLAIN	WSTM5	100
M5 CAPPED	WSTM5C	100
M6 PLAIN	WSTM6	100
M6 CAPPED	WSTM6C	100
M8 PLAIN	WSTM8	100
M8 CAPPED	WSTM8C	100
M10 PLAIN	WSTM10	100
M10 CAPPED	WSTM10C	100
M12 PLAIN	WSTM12	100
M12 CAPPED	WSTM12C	100

EPDM WASHERS

ROUND AND SQUARE



SIZE	PART #	PACK QTY
M8 X 19	WNEOM819	100
M8 X 22 X 3	WNEOM822	100
M10 X 25 X 3	WNEO10253	100
M10 X 40 X 3	WNEO10403	100
M12 X 50 X 3	WNEO12503	100

SIZE	PART #	PACK QTY
M10 X 50 X 3	WNEO1050B	100
M12 X 50 X 3	WNEO1250B	100
M16 X 50 X 3	WNEO1650B	100

Sizes outside of range available upon request.
Subject to availability.

WEDGE LOCK WASHER

ZINC FLAKE STAINLESS STEEL T316



SIZE	PART #
M4 WEDGE LOCK WASHER (5/32)	WWLM4
M5 WEDGE LOCK WASHER (3/16)	WWLM5
M6 WEDGE LOCK WASHER (1/4)	WWLM6
M8 WEDGE LOCK WASHER (5/16)	WWLM8
M10 WEDGE LOCK WASHER (3/8)	WWLM10
M12 WEDGE LOCK WASHER (1/2)	WWLM12
M14 WEDGE LOCK WASHER (9/16)	WWLM14
M16 WEDGE LOCK WASHER (5/8)	WWLM16
M18 WEDGE LOCK WASHER	WWLM18
M20 WEDGE LOCK WASHER	WWLM20
M22 WEDGE LOCK WASHER (7/8)	WWLM22
M24 WEDGE LOCK WASHER	WWLM24
M30 WEDGE LOCK WASHER	WWLM30

SIZE	PART #
M4 WEDGE LOCK WASHER S/S T316	WWLXM4
M6 WEDGE LOCK WASHER S/S T316	WWLXM6
M8 WEDGE LOCK WASHER S/S T316	WWLXM8
M10 WEDGE LOCK WASHER S/S T316	WWLXM10
M12 WEDGE LOCK WASHER S/S T316	WWLXM12
M16 WEDGE LOCK WASHER S/S T316	WWLXM16
M20 WEDGE LOCK WASHER S/S T316	WWLXM20



Functional Principle

An important feature of Wedge Lock Washers, setting them apart from other systems that are available, is the securing of the bolt fastening using preload force rather than friction

Wedge-shaped cams on the inside of the lock washers, radial teeth on the outside Interlocking embedding of the radial teeth with the respective mating surface (when tightening the bolted joint)

System movement only possible between the inner wedge shaped cams. Movement across these wedge shaped surfaces effectively self locks the bolt Increase in clamping force

INNOVATIVE FASTENING SOLUTIONS FOR EVERY NEED

Fortress Fasteners Enquiries

0800 42 52 62 | sales@steelandtube.co.nz | steelandtube.co.nz

2

SCREWS FOR TIMBER



2 SCREWS FOR TIMBER

SCREWS FOR TIMBER SELECTION GUIDE

SCREW POINTS INFORMATION



TYPE AB

This point is found on Type AB self tapping screws and a range of screws used for fastening timber or timber based building products. Its purpose is to assist the screw in engaging in the material being fastened.



LEAD POINT

This point is found on self tapping screws and a range of other screws used for fastening in a situation where the pilot hole cannot be easily located. The Lead point self located the screw into the pilot hole for fastening.



TYPE B

This point is applied to self tapping screws and generally specified where the screw is being driven into a shallow hole. Type B points provide for more full threads to be engaged in the material being fastened.



TYPE 17

Similar to the Type AB point, except that the screw material has been cut away. This feature, some times called a shank shot provides the ability for the screw to self drill through thin metal and then drill into timber members of the structure.



TYPE 25

A point designed to cut through threads in plastic material. The presence of the shank slot provides the cutting ability and also for the clearance of cutting chips.



TYPE 23

Fasteners with this cutting thread point are designed for use in soft metals or die castings. Threads produced belong to the machine thread series.



WINGED DRILL

In thicker building materials such as plywood, hardboard or cement sheet, the addition of wings cuts a slightly oversize hole permitting clear passage of the thread to engage with supporting steel structural members.



DRILL

A point designed to fasten material of varying types to steel. The shape of the drill point gives the fastener the ability to drill its own hole in most materials including steel.

DECKING SCREWS - RAISED CSK

STAINLESS STEEL T304 STAINLESS STEEL T316

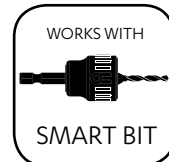
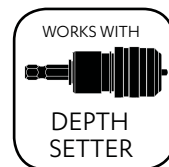
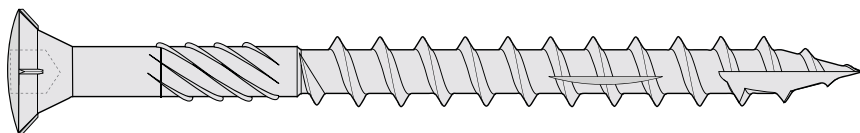
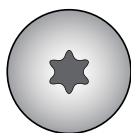

Unique cutting system offers fast fixing into hardwood decking



Double thread firmly embeds for a tight finish helping to reduce cupping of board

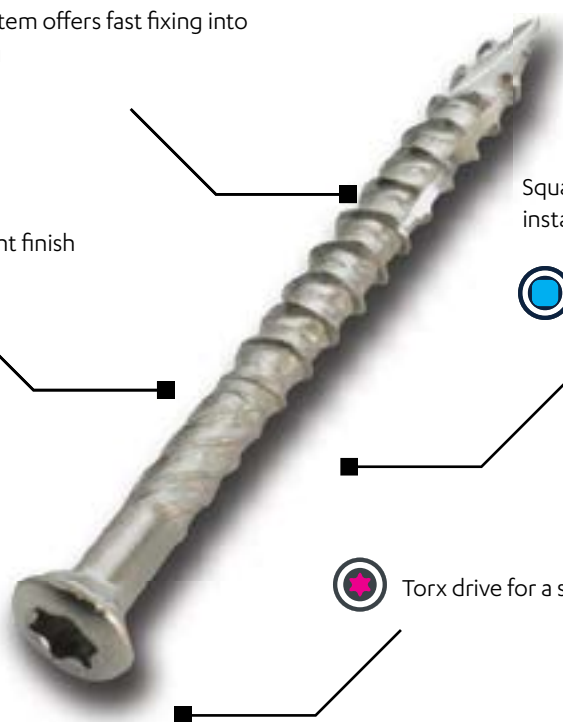

Square thread reduces resistance during installation



Torx drive for a stronger installation

T304 PART #	BOX CODE	DESCRIPTION	PACK QTY	BOX QTY
DECKX850P100	DECKX850P	8G X 50	100	1000
DECKX865P100	DECKX865P	8G X 65	100	1000
DECKX1060P100	DECKX1060P	10G X 60	100	1000
DECKX1075P100	DECKX1075P	10G X 75	100	1000
DECKX1275P100	DECKX1275P	12G X 75	100	1000
DECKX1290P100	DECKX1290P	12G X 90	100	1000

T316 PART

DECKX1060TP100	DECKX1060TP	10G X 60	100	1000
DECKX1075TP100	DECKX1075TP	10G X 75	100	1000
DECKX1275TP100	DECKX1275TP	12G X 75	100	1000
DECKX1290TP100	DECKX1290TP	12G X 90	100	1000

2 SCREWS FOR TIMBER

DECKING SCREWS - CSK

T304 STAINLESS STEEL T316 STAINLESS STEEL

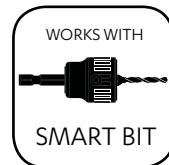
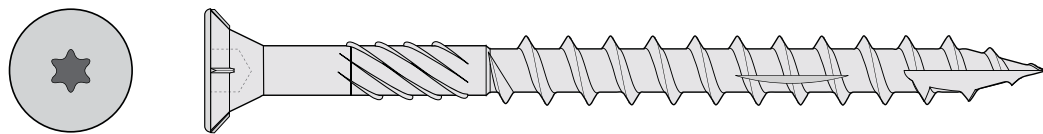

 Unique cutting system offers fast fixing into hardwood decking



Double thread firmly embeds for a tight finish helping to reduce cupping of board

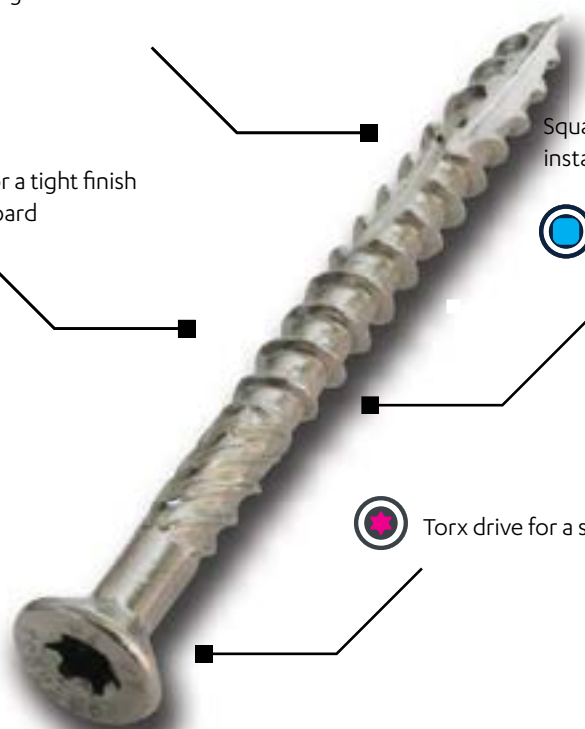

Square thread reduces resistance during installation

 Torx drive for a stronger installation

T304 PART #	BOX CODE	DESCRIPTION	PACK QTY	BOX QTY
DECKXCSK1060P100	DECKXCSK1060P	10G X 60	100	1000
DECKXCSK1075P100	DECKXCSK1075P	10G X 75	100	1000
DECKX12100P100	DECKX12100P	12G X 100	100	1000
DECKX12120P100	DECKX12120P	12G X 120	100	1000

T316 PART #	BOX CODE	DESCRIPTION	PACK QTY	BOX QTY
DECKXCSK1060TP100	DECKXCSK1060TP	10G X 60	100	1000
DECKXCSK1075TP100	DECKXCSK1075TP	10G X 75	100	1000

DECKING SCREWS - BRONZE

BRONZED 304 STAINLESS STEEL

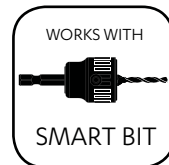



 Unique cutting system offers fast fixing into hardwood decking

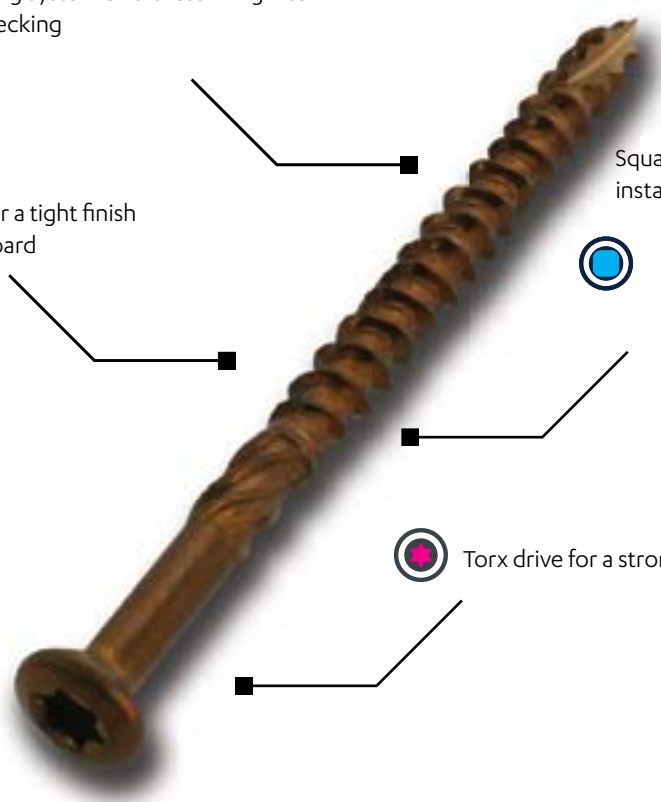

Double thread firmly embeds for a tight finish helping to reduce cupping of board

Square thread reduces resistance during installation



 Torx drive for a stronger installation

T304 - RAISED COUNTERSUNK PART #	BOX CODE	DESCRIPTION	PACK QTY	BOX QTY
DECKX1060BR100	DECKX1060BR	10G X 60	100	1000
DECKX1075BR100	DECKX1075BR	10G X 75	100	1000
DECKX1275BR100	DECKX1275BR	12G X 75	100	1000
DECKX1290BR100	DECKX1290BR	12G X 90	100	1000

T304 - COUNTERSUNK PART #	BOX CODE	DESCRIPTION	PACK QTY	BOX QTY
DECKXCSK1060BR100	DECKXCSK1060BR	10G X 60	100	1000
DECKXCSK1075BR100	DECKXCSK1075BR	10G X 75	100	1000
DECKXCSK1275BR100	DECKXCSK1275BR	12G X 75	100	1000

2 SCREWS FOR TIMBER

DECKING SCREWS

DIMENSIONS

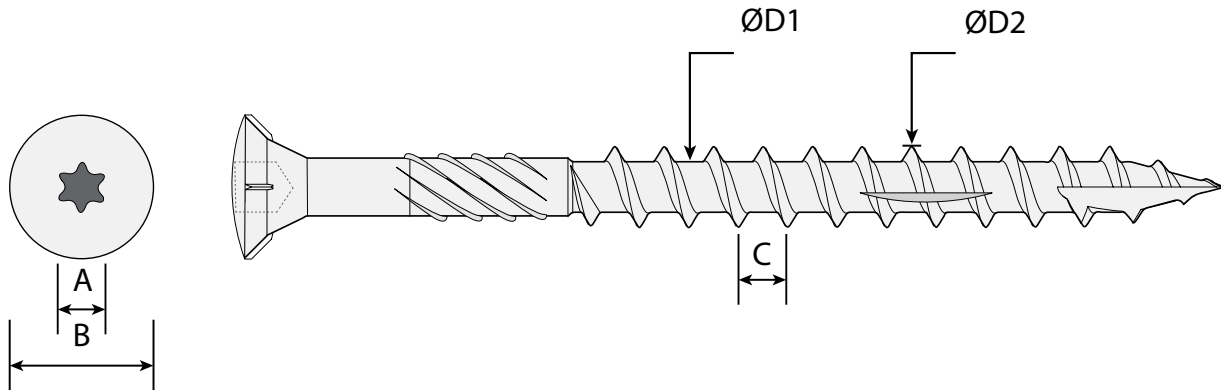

SCREW GAUGE	DRIVE (A)	HEAD DIA (B)	PITCH (C)	MIN DIA (D1)	MAJOR DIA (D2)
8 GAUGE	TORX 25	7mm	3mm	3.4mm	4.7-5.0mm
10 GAUGE	TORX 25	8mm	3mm	3.6mm	5.0-5.4mm
12 GAUGE	TORX 25	10mm	3mm	3.9mm	5.3-5.7mm



SKARA SCREWS - PAN WASHER

CLASS 4

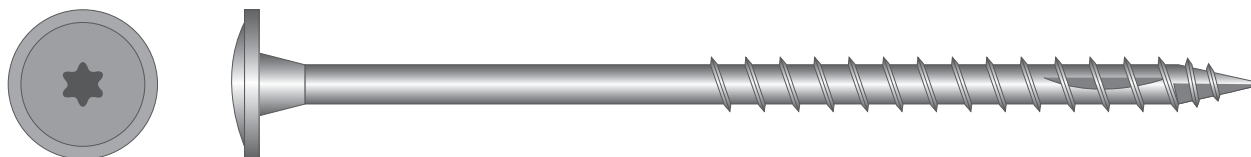

PART #	SIZE	TORX	PACK QTY
SKAPWTM680C4	M6 X 80	T-30	100
SKAPWTM6100C4	M6 X 100	T-30	100
SKAPWTM6120C4	M6 X 120	T-30	100
SKAPWTM6140C4	M6 X 140	T-30	100
SKAPWTM6160C4	M6 X 160	T-30	100
SKAPWTM6180C4	M6 X 180	T-30	100
SKAPWTM880C4	M8 X 80	T-40	50
SKAPWTM8100C4	M8 X 100	T-40	50
SKAPWTM8120C4	M8 X 120	T-40	50
SKAPWTM8140C4	M8 X 140	T-40	50
SKAPWTM8160C4	M8 X 160	T-40	50
SKAPWTM8200C4	M8 X 200	T-40	50
SKAPWTM1080C4	M10 X 80	T-50	50
SKAPWTM10100C4	M10 X 100	T-50	50
SKAPWTM10120C4	M10 X 120	T-50	50
SKAPWTM10140C4	M10 X 140	T-50	50
SKAPWTM10160C4	M10 X 160	T-50	25
SKAPWTM10180C4	M10 X 180	T-50	25
SKAPWTM10200C4	M10 X 200	T-50	25
SKAPWTM10220C4	M10 X 220	T-50	25
SKAPWTM10240C4	M10 X 240	T-50	25
SKAPWTM10260C4	M10 X 260	T-50	25
SKAPWTM10280C4	M10 X 280	T-50	25
SKAPWTM10300C4	M10 X 300	T-50	25
SKAPWTM10360C4	M10 X 360	T-50	25

2 SCREWS FOR TIMBER

SKARA SCREWS - PAN WASHER

STAINLESS STEEL T304



PART #	SIZE	TORX	PACK QTY
SKAPWTXM660	M6 X 60	T-25	100
SKAPWTXM680	M6 X 80	T-25	100
SKAPWTXM6100	M6 X 100	T-25	100
SKAPWTXM6120	M6 X 120	T-25	100
SKAPWTXM6140	M6 X 140	T-25	100
SKAPWTXM6160	M6 X 160	T-25	100
SKAPWTXM6200	M6 X 200	T-25	100
SKAPWTXM880	M8 X 80	T-40	50
SKAPWTXM8100	M8 X 100	T-40	50
SKAPWTXM8120	M8 X 120	T-40	50
SKAPWTXM8140	M8 X 140	T-40	50
SKAPWTXM8160	M8 X 160	T-40	50
SKAPWTXM8180	M8 X 180	T-40	50
SKAPWTXM8200	M8 X 200	T-40	50

SKARA SCREWS - CSK

CLASS 4

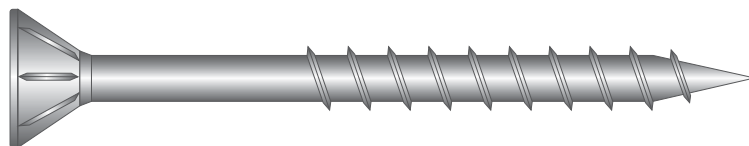
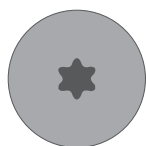

PART #	SIZE	TORX	PACK QTY
SKACTM8100C4	M8 X 100	T-40	50
SKACTM8120C4	M8 X 120	T-40	50
SKACTM8140C4	M8 X 140	T-40	50
SKACTM10100C4	M10 X 100	T-40	50
SKACTM10120C4	M10 X 120	T-40	50
SKACTM10140C4	M10 X 140	T-40	50
SKACTM10160C4	M10 X 160	T-40	25

SKARA SCREWS - REAMER

CLASS 3

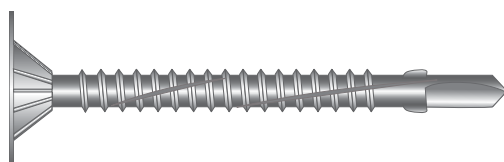
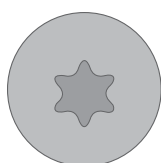

PART #	SIZE	TORX	PACK QTY
TKCWT1455C3	14G X 55mm	T-30	50
TKCWT1465C3	14G X 65mm	T-30	50
TKCWT1480C3	14G X 80mm	T-30	50
TKCWT14110C3	14G X 110mm	T-30	50
TKCWT14130C3	14G X 130mm	T-30	50

2 SCREWS FOR TIMBER

SKARA SCREWS - CSK

STAINLESS STEEL T304

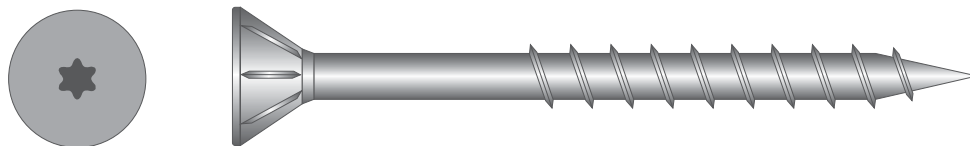

PART #	SIZE	TORX	PACK QTY
SKACWTXM660	M6 X 60	T-25	100
SKACWTXM680	M6 X 80	T-25	100
SKACWTXM6100	M6 X 100	T-25	100
SKACWTXM6120	M6 X 120	T-25	100
SKACWTXM6140	M6 X 140	T-25	100
SKACWTXM6160	M6 X 160	T-25	100
SKACWTXM6200	M6 X 200	T-25	100
SKACWTXM880	M8 X 80	T-40	50
SKACWTXM8100	M8 X 100	T-40	50
SKACWTXM8120	M8 X 120	T-40	50
SKACWTXM8140	M8 X 140	T-40	50
SKACWTXM8160	M8 X 160	T-40	50
SKACWTXM8200	M8 X 200	T-40	50

T17 BUGLE BATTEN SCREW

CLASS 4 STAINLESS STEEL T316 ZINC CHROMATE

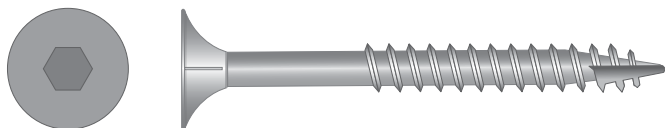

PART #	PART #	PART #	SIZE	HEX mm	ED(mm)	PACK QTY
TTB1450C4	TTBX1450T	TTB1450C2	14G X 50mm	5	30	100
	TTBX1463T		14G X 63mm	5	30	100
TTB1475C4	TTBX1475T	TTB1475C2	14G X 75mm	5	35	100
TTB1490C4	TTBX1490T		14G X 90mm	5	35	100
TTB14100C4	TTBX14100T	TTB14100C2	14G X 100mm	5	35	100
	TTBX14120T		14G X 120mm	5	35	100
TTB14125C4			14G X 125mm	5	35	100
TTB14150C4	TTBX14150T		14G X 150mm	5	35	100
TTB14200C4			14G X 200mm	5	35	100

T17 BATTEN SCREW BUGLE HEAD - TRADE PACKS

CLASS 4

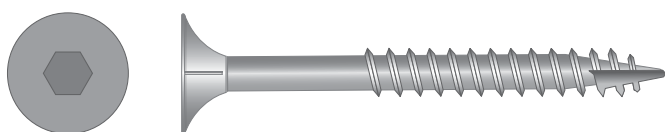

PART #	SIZE	HEX mm	ED(mm)	PACK QTY
TTB14100C4P250	14G x 100mm	5	30	250
TTB14100C4P500	14G x 100mm	5	35	500



2 SCREWS FOR TIMBER

T17 HEX WASHER FACE SCREW

ZINC CHROMATE CLASS 4

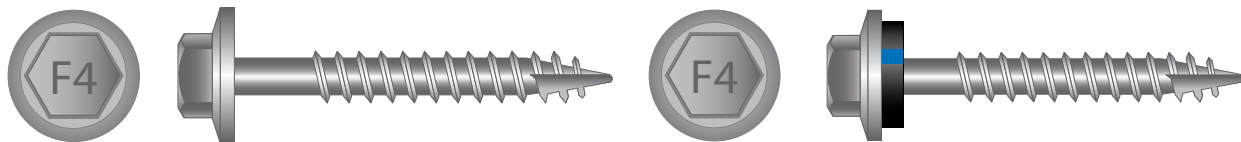

PART # - NO NEO	PART # - NO NEO	PART # - NEO	SIZE	HEAD	MT(mm)	PACK QTY
TT1225C2	TT1225C4	TT1225NC4	12-14 X 25	HEX 5/16	1.00-4.50	200
	TT1235C4	TT1235NC4	12-14 X 35	HEX 5/16	1.00-4.50	200
	TT1240C4		12-14 X 40	HEX 5/16	1.00-4.50	200
TT1245C2	TT1245C4	TT1245NC4	12-14 X 45	HEX 5/16	1.00-4.50	200
TT1250C2	TT1250C4	TT1250NC4	12-14 X 50	HEX 5/16	1.00-4.50	200
	TT1255C4	TT1255NC4	12-14 X 55	HEX 5/16	1.00-4.50	200
TT1265C2	TT1265C4	TT1265NC4	12-14 X 65	HEX 5/16	1.00-4.50	100
	TT1425C4		14-10 X 25	HEX 3/8	1.00-5.00	100
TT1450C2	TT1450C4	TT1450NC4	14-10 X 50	HEX 3/8	1.00-5.00	100
	TT1455C4		14-10 X 55	HEX 3/8	1.00-5.00	100
TT1465C2	TT1465C4	TT1465NC4	14-10 X 65	HEX 3/8	1.00-5.00	100
	TT1475C4	TT1475NC4	14-10 X 75	HEX 3/8	1.00-5.00	100
	TT1490C4	TT1490NC4	14-10 X 90	HEX 3/8	1.00-5.00	100
TT14100C2	TT14100C4	TT14100NC4	14-10 X 100	HEX 3/8	1.00-5.00	100
	TT14115C4	TT14115NC4	14-10 X 115	HEX 3/8	1.00-5.00	100
	TT14125C4		14-10 X 125	HEX 3/8	1.00-5.00	100
	TT14150C4		14-10 X 150	HEX 3/8	1.00-5.00	100
	TT14200C4		14-10 X 200	HEX 3/8	1.00-5.00	100

Sizes outside of range available upon request. Subject to availability.

T17 HEX WASHER FACE SCREW

STAINLESS STEEL T304 STAINLESS STEEL T316

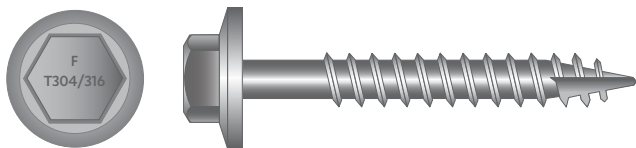

PART #	SIZE	HEAD	PACK QTY
TTX1225	12G -11TPI X 25mm	5/16"	200
TTX1235	12G -11TPI X 35mm	5/16"	200
TTX1235J	12G -11TPI X 35mm (JAR)	5/16"	25
TTX1435	14G -10TPI X 35mm	3/8"	200
TTX1450	14G -10TPI X 50mm	3/8"	200
TTX1475	14G -10TPI X 75mm	3/8"	100
TTX1490	14G -10TPI X 90mm	3/8"	100
TTX14125	14G -10TPI X 125mm	3/8"	100
TTX1250N	12G -11TPI X 50mm WITH NEO	5/16"	200
TTX1255N	12G -11TPI X 55mm WITH NEO	5/16"	200
TTX1265N	12G -11TPI X 65mm WITH NEO	5/16"	100

PART #	SIZE	HEAD	PACK QTY
TTX1235T	12G -11TPI X 35mm	5/16"	200
TTX1245T	12G -11TPI X 45mm	5/16"	200
TTX1435T	14G -10TPI X 35mm	3/8"	200
TTX1435TJ	14G -10TPI X 35mm (JAR)	3/8"	25
TTX1475T	14G -10TPI X 75mm	3/8"	100
TTX1475TJ	14G -10TPI X 75mm (JAR)	3/8"	25

Sizes outside of range available upon request. Subject to availability.

2 SCREWS FOR TIMBER

GYPSUM SCREWS

ZINC CHROMATE

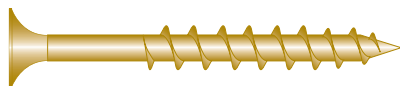

Coarse Thread



Fine Thread

COARSE PACK #	COARSE JAR #	FINE PACK #	FINE JAR #	SIZE	PHILLIPS	PACK QTY	JAR QTY
GYP625C	GYP625CJ	GYP625F	GYP625FJ	6G X 25mm	#1	1000	200
GYP632C	GYP632CJ	GYP632F	GYP632FJ	6G X 32mm	#1	1000	200
GYP645C	GYP645CJ	GYP645F	GYP645FJ	6G X 45mm	#1	1000	200
GYP732C				7G X 32mm	#2	1000	200
GYP832C				8G X 32mm	#2	1000	200

SDS GYPSUM SCREW

ZINC CHROMATE

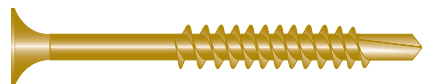

PACK #	JAR #	SIZE	PHILLIPS	PACK QTY	JAR QTY
TKGYP625	TKGYP625J	6G X 25mm	#1	1000	200
TKGYP632	TKGYP632J	6G X 32mm	#1	1000	200
TKGYP645	TKGYP645J	6G X 45mm	#1	1000	200

GYPSUM SCREWS COLLATED

ZINC CHROMATE

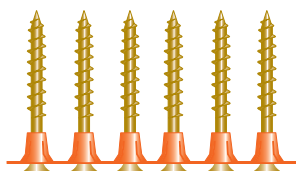

Coarse Thread

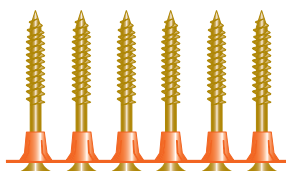

Fine Thread

PART #	PART #	SIZE	PHILLIPS	PACK QTY
GYPOL625C	GYPOL625F	6G X 25mm	#1	1000
GYPOL632C	GYPOL632F	6G X 32mm	#1	1000
GYPOL640C	GYPOL640F	6G X 40mm	#1	1000
GYPOL850C		8G X 50mm	#2	500
GYPOL857C		8G X 57mm	#2	500

SDS GYPSUM SCREWS COLLATED

ZINC CHROMATE

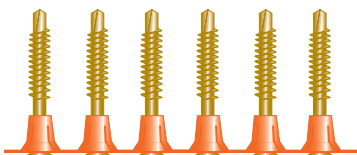

PART #	SIZE	PHILLIPS	PACK QTY
TKGYCOL625	6G X 25mm	#1	1000
TKGYCOL632	6G X 32mm	#1	1000
TKGYCOL640	6G X 40mm	#1	1000

2 SCREWS FOR TIMBER

COLLATED SUREFAST SCREWS

ZINC CHROMATE STAINLESS STEEL T316

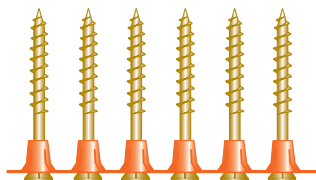

PART #	PART #	SIZE	PHILLIPS	PACK QTY
SFCOL840	SFCOLX840	8G X 40mm	#2	1000
SFCOL850	SFCOLX850	8G X 50mm	#2	500
SFCOL857		8G X 57mm	#2	500

SUREFAST SCREWS

STAINLESS STEEL T304

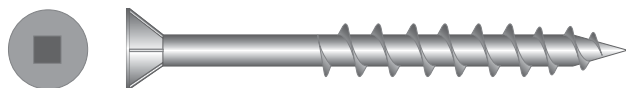

PACK #	JAR #	SIZE	SQUARE	PACK QTY	JAR QTY
SFQX820P	SFQX820J	8G X 20mm	#2	1000	200
SFQX825P	SFQX825J	8G X 25mm	#2	1000	200
SFQX832P	SFQX832J	8G X 32mm	#2	1000	200
SFQX840P	SFQX840J	8G X 40mm	#2	1000	200
SFQX845P	SFQX845J	8G X 45mm	#2	1000	200
SFQX850P	SFQX850J	8G X 50mm	#2	1000	100
SFQX865P	SFQX865J	8G X 65mm	#2	500	100
SFQX1050P	SFQX1050J	10G X 50mm	#2	500	100
SFQX1065P	SFQX1065J	10G X 65mm	#2	500	100
SFQX1075P	SFQX1075J	10G X 75mm	#2	500	50
SFQX1090P	SFQX1090J	10G X 90mm	#2	250	50
SFQX10100P	SFQX10100J	10G X 100mm	#2	250	50
SFQX1250P	SFQX1250J	12G X 50mm	#3	250	50
SFQX1265P	SFQX1265J	12G X 65mm	#3	250	50

SUREFAST SCREWS

CLASS 3 ZINC CHROMATE



PACK #	JAR #	PACK #	JAR #	SIZE	SQUARE	PACK QTY	JAR QTY
		SFQ616P	SFQ616J	6G X 16mm	#1	1000	200
		SFQ620P	SFQ620J	6G X 20mm	#1	1000	200
		SFQ625P	SFQ625J	6G X 25mm	#1	1000	200
		SFQ632P	SFQ632J	6G X 32mm	#1	1000	200
		SFQ640P	SFQ640J	6G X 40mm	#1	1000	200
		SFQ816P	SFQ816J	8G X 16mm	#2	1000	200
		SFQ820P	SFQ820J	8G X 20mm	#2	1000	200
SFQ825CL3P	SFQ825CL3J	SFQ825P	SFQ825J	8G X 25mm	#2	1000	200
		SFQ828P	SFQ828J	8G X 28mm	#2	1000	200
SFQ832CL3P	SFQ832CL3J	SFQ832P	SFQ832J	8G X 32mm	#2	1000	200
SFQ840CL3P	SFQ840CL3J	SFQ840P	SFQ840J	8G X 40mm	#2	1000	200
SFQ845CL3P	SFQ845CL3J	SFQ845P	SFQ845J	8G X 45mm	#2	1000	200
SFQ850CL3P	SFQ850CL3J	SFQ850P	SFQ850J	8G X 50mm	#2	1000	100
SFQ865CL3P	SFQ865CL3J	SFQ865P	SFQ865J	8G X 65mm	#2	500	100
SFQ1050CL3P	SFQ1050CL3J	SFQ1050P	SFQ1050J	10G X 50mm	#2	500	100
SFQ1065CL3P	SFQ1065CL3J	SFQ1065P	SFQ1065J	10G X 65mm	#2	500	100
SFQ1075CL3P	SFQ1075CL3J	SFQ1075P	SFQ1075J	10G X 75mm	#2	500	50
SFQ1090CL3P	SFQ1090CL3J	SFQ1090P	SFQ1090J	10G X 90mm	#2	250	50
SFQ10100CL3P	SFQ10100CL3J	SFQ10100P	SFQ10100J	10G X 100mm	#2	250	50
SFQ1232CL3P	SFQ1232CL3J			12G X 32mm	#3	250	50
SFQ1240CL3P	SFQ1240CL3J			12G X 40mm	#3	250	50
SFQ1250CL3P	SFQ1250CL3J			12G X 50mm	#3	250	50
SFQ1265CL3P	SFQ1265CL3J			12G X 65mm	#3	250	50

2 SCREWS FOR TIMBER

SUREFAST SCREWS PAN SQUARE

CLASS 4

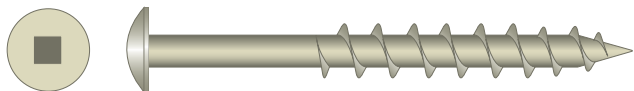

PACK #	JAR #	SIZE	SQUARE	PACK QTY	JAR QTY
SFPQ812C4	SFPQ812C4J	8G X 12mm	#2	1000	200
SFPQ820C4	SFPQ820C4J	8G X 20mm	#2	1000	200
SFPQ825C4	SFPQ825C4	8G X 25mm	#2	1000	200

SUREFAST SCREWS PAN POZI

ZINC CHROMATE



PACK #	SIZE	POZI	PACK QTY
SFPP812	8G X 12mm	#2	1000
SFPP816	8G X 16mm	#2	1000
SFPP820	8G X 20mm	#2	1000
SFPP825	8G X 25mm	#2	1000
SFPP832	8G X 32mm	#2	1000

PURLIN BLUE SCREW

BLUE RUSPERT

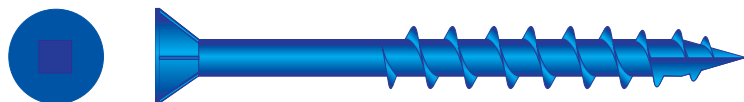

PART #	SIZE	SQUARE	PACK QTY
PUR1080BP500	10G X 80mm	#2	500
PUR1080BP100	10G X 80mm	#2	100

COMPRESSED SHEET SCREW

STAINLESS STEEL T316

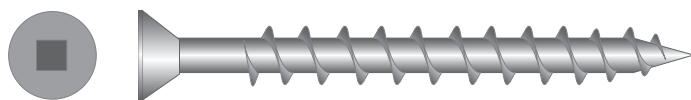

PART #	SIZE	SQUARE	PACK QTY
COMPX1040T	10G X 40mm	#2	1000
COMPX1050T	10G X 50mm	#2	1000

JOLT HEAD TIMBER SCREW

CLASS 3 GALVANISED STAINLESS STEEL T316



PART #	PART #	SIZE	TORX	PACK QTY
JOLT865C3	JOLT865T	8G X 65mm	T15	200
JOLT875C3	JOLT875T	8G X 75mm	T15	200
JOLT890C3	JOLT890T	8G X 90mm	T15	200

2 SCREWS FOR TIMBER

TWINFAST SCREWS

ZINC PLATED

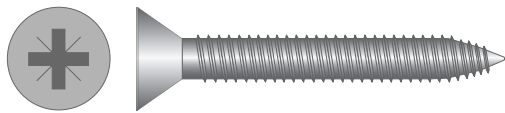

PACK #	JAR #	SIZE	PACK QTY	JAR QTY
TF412Z	TF412ZJ	4G X 12	1000	200
TF416Z	TF416ZJ	4G X 16	1000	200
TF420Z	TF420ZJ	4G X 20	1000	200
TF512Z	TF512ZJ	5G X 12	1000	200
TF516Z	TF516ZJ	5G X 16	1000	200
TF520Z	TF520ZJ	5G X 20	1000	200
TF525Z	TF525ZJ	5G X 25	1000	200
TF612Z	TF612ZJ	6G X 12	1000	200
TF616Z	TF616ZJ	6G X 16	1000	200
TF620Z	TF620ZJ	6G X 20	1000	200
TF625Z	TF625ZJ	6G X 25	1000	200
TF632Z	TF632ZJ	6G X 32	1000	200
TF640Z	TF640ZJ	6G X 40	1000	200
TF716Z	TF716ZJ	7G X 16	1000	200
TF720Z	TF720ZJ	7G X 20	1000	200
TF725Z	TF725ZJ	7G X 25	1000	200
TF732Z	TF732ZJ	7G X 32	1000	200
TF740Z	TF740ZJ	7G X 40	1000	200
TF812Z		8G X 12	1000	

PACK #	JAR #	SIZE	PACK QTY	JAR QTY
TF816Z	TF816ZJ	8G X 16	1000	200
TF820Z	TF820ZJ	8G X 20	1000	200
TF825Z	TF825ZJ	8G X 25	1000	200
TF832Z	TF832ZJ	8G X 32	1000	200
TF840Z	TF840ZJ	8G X 40	1000	200
TF845Z	TF845ZJ	8G X 45	1000	200
TF850Z	TF850ZJ	8G X 50	1000	100
TF920Z	TF920ZJ	9G X 20	1000	200
TF925Z	TF925ZJ	9G X 25	1000	200
TF932Z	TF932ZJ	9G X 32	1000	200
TF940Z	TF940ZJ	9G X 40	1000	200
	TF945ZJ	9G X 45	1000	100
TF950Z	TF950ZJ	9G X 50		100
TF1020Z	TF1020ZJ	10G X 20	1000	200
TF1025Z	TF1025ZJ	10G X 25	1000	200
TF1032Z	TF1032ZJ	10G X 32	1000	200
TF1040Z	TF1040ZJ	10G X 40	1000	200
TF1045Z	TF1045ZJ	10G X 45	1000	100
TF1050Z	TF1050ZJ	10G X 50	1000	100

Fortress Fasteners Enquiries

0800 42 52 62 | sales@steelandtube.co.nz | steelandtube.co.nz

3

SCREWS FOR METAL



3 SCREWS FOR METAL

SDS HEX WASHER FACE SCREW

ZINC CHROMATE CLASS 4

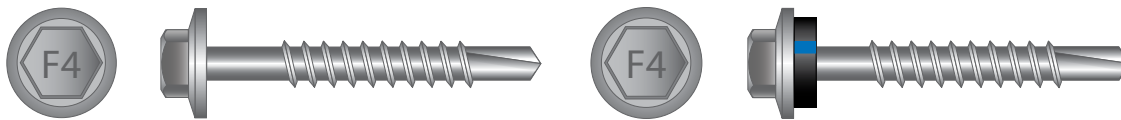

PART # NO NEO	PART # NO NEO	PART # WITH NEO	SIZE	HEAD	MT(mm)	PACK QTY
TK812C2	TK812C4		8-18 X 12	HEX 1/4	0.75-2.5	1000
	TK816C4		8-18 X 16	HEX 1/4	0.75-2.5	1000
	TK820C4		8-18 X 20	HEX 1/4	0.75-2.5	1000
TK1016C2	TK1016C4	TK1016NC4	10-16 X 16	HEX 5/16	0.75-3.50	1000
TK1025C2	TK1025C4	TK1025NC4	10-16 X 25	HEX 5/16	0.75-3.50	500
TK1220C2	TK1220C4	TK1220NC4	12-14 X 20	HEX 5/16	1.00-4.50	200
	TK1225C4	TK1225NC4	12-14 X 25	HEX 5/16	1.00-4.50	200
	TK1235C4	TK1235NC4	12-14 X 35	HEX 5/16	1.00-4.50	200
TK1245C2	TK1245C4	TK1245NC4	12-14 X 45	HEX 5/16	1.00-4.50	200
	TK1255C4	TK1255NC4	12-14 X 55	HEX 5/16	1.00-4.50	200
	TK1265C4	TK1265NC4	12-14 X 65	HEX 5/16	1.00-4.50	100
TK1422C2	TK1422C4	TK1422NC4	14-10 X 22	HEX 3/8	1.00-5.00	200
	TK1430C4		14-10 X 30	HEX 3/8	1.00-5.00	200
	TK1475C4	TK1475NC4	14-10 X 75	HEX 3/8	1.00-5.00	100
	TK1490C4	TK1490NC4	14-10 X 90	HEX 3/8	1.00-5.00	100
	TK14115C4	TK14115NC4	14-10 X 115	HEX 3/8	1.00-5.00	100
		TK14135NC4	14-10 X 135	HEX 3/8	1.00-5.00	100
		TK14150NC4	14-10 X 150	HEX 3/8	1.00-5.00	100

Sizes outside of range available upon request. Subject to availability.

SDS HEX WASHER FACE SCREW

STAINLESS STEEL

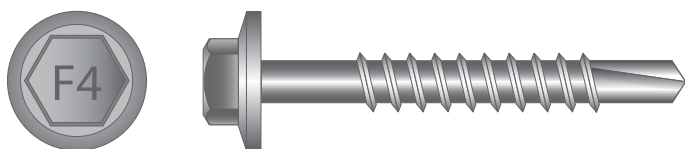

PART #	SIZE	HEAD	PACK QTY
TKX1225	12G X 25	HEX 5/16	200
TKX1225BI	12G X 25 BI METAL	HEX 5/16	200
TKX1235	12G X 35	HEX 5/16	200
			200
TKX1425	14G X 25	HEX 3/8	200
TKX1425BI	14G X 25 BI METAL	HEX 3/8	100
TKX1432	14G X 32	HEX 3/8	100
TKX1435	14G X 35	HEX 3/8	200
TKX1450	14G X 50	HEX 3/8	200
TKX1475BI	14G X 75 BI METAL	HEX 3/8	200
TKX1490	14G X 90	HEX 3/8	200

Sizes outside of range available upon request. Subject to availability.

ROOF X FAST

SCREWS

SUPERIOR DRILLING PERFORMANCE

Dual point screw - suitable for drilling into all timber applications and steel up to 3mm thick

Mechanical Properties to AS3566.1 2002

Top-grip thread for superior holding power

Packed in plastic free cardboard boxes of 500

Premium mechanical galvanised coating suitable for use in ISO 9223 Environmental Categories (Class 5)

Available in a range of coloured heads to match NZ Colorsteel colours

6mm diameter - available in 3 lengths 35, 55 and 65mm

Quality DEKS Neoprene Sealing Washer

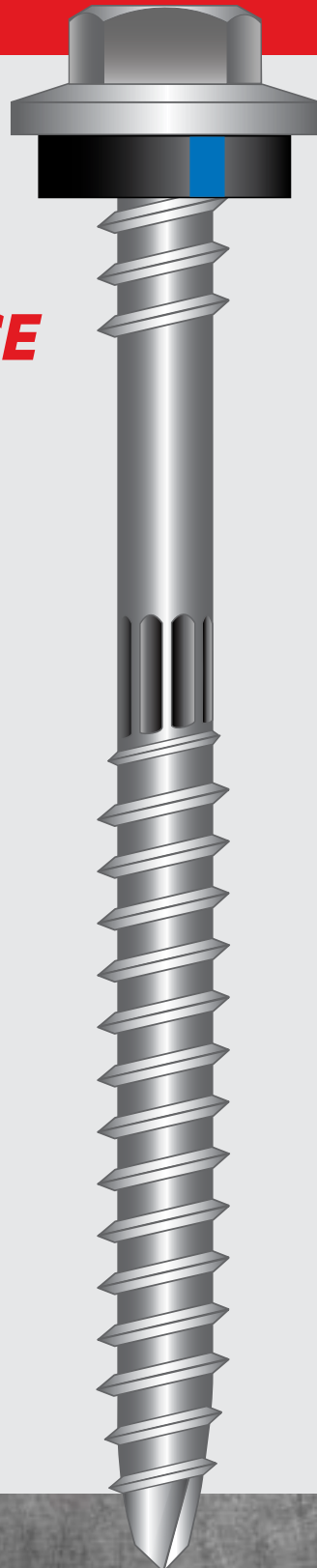

Available from Steel & Tube Roofing and Fortress Fasteners

ROOF FAST SCREWS

CLASS 5

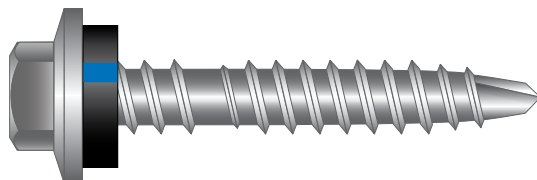

PART #	SIZE	COLOUR	HEAD	MATERIAL	PACK QTY
RFM635NC5	6mm-11TPI X 35mm	PLAIN	5/16" HEX	TIMBER / STEEL ≤3mm	500
RFM635NC5CL	6mm-11TPI X 35mm	CLOUD	5/16" HEX	TIMBER / STEEL ≤3mm	500
RFM635NC5DS	6mm-11TPI X 35mm	DESERT SAND	5/16" HEX	TIMBER / STEEL ≤3mm	500
RFM635NC5EB	6mm-11TPI X 35mm	EBONY	5/16" HEX	TIMBER / STEEL ≤3mm	500
RFM635NC5FP	6mm-11TPI X 35mm	FLAXPOD	5/16" HEX	TIMBER / STEEL ≤3mm	500
RFM635NC5GF	6mm-11TPI X 35mm	GREY FRIARS	5/16" HEX	TIMBER / STEEL ≤3mm	500
RFM635NC5GG	6mm-11TPI X 35mm	GULL GREY	5/16" HEX	TIMBER / STEEL ≤3mm	500
RFM635NC5IS	6mm-11TPI X 35mm	IRONSAND	5/16" HEX	TIMBER / STEEL ≤3mm	500
RFM635NC5KA	6mm-11TPI X 35mm	KARAKA	5/16" HEX	TIMBER / STEEL ≤3mm	500
RFM635NC5LG	6mm-11TPI X 35mm	LIGNITE	5/16" HEX	TIMBER / STEEL ≤3mm	500
RFM635NC5LI	6mm-11TPI X 35mm	LICHEN	5/16" HEX	TIMBER / STEEL ≤3mm	500
RFM635NC5MG	6mm-11TPI X 35mm	MIST GREEN	5/16" HEX	TIMBER / STEEL ≤3mm	500
RFM635NC5NDB	6mm-11TPI X 35mm	NEW DENIM BLUE	5/16" HEX	TIMBER / STEEL ≤3mm	500
RFM635NC5PG	6mm-11TPI X 35mm	PERMANENT GREEN	5/16" HEX	TIMBER / STEEL ≤3mm	500
RFM635NC5PR	6mm-11TPI X 35mm	PIONEER RED	5/16" HEX	TIMBER / STEEL ≤3mm	500
RFM635NC5SB	6mm-11TPI X 35mm	SANDBAR	5/16" HEX	TIMBER / STEEL ≤3mm	500
RFM635NC5SC	6mm-11TPI X 35mm	SCORIA	5/16" HEX	TIMBER / STEEL ≤3mm	500
RFM635NC5SG	6mm-11TPI X 35mm	SANDSTONE GREY	5/16" HEX	TIMBER / STEEL ≤3mm	500
RFM635NC5SL	6mm-11TPI X 35mm	SLATE	5/16" HEX	TIMBER / STEEL ≤3mm	500
RFM635NC5SP	6mm-11TPI X 35mm	STONEPEAK	5/16" HEX	TIMBER / STEEL ≤3mm	500
RFM635NC5SS	6mm-11TPI X 35mm	SANDSCAPE	5/16" HEX	TIMBER / STEEL ≤3mm	500
RFM635NC5TD	6mm-11TPI X 35mm	TIDALDRIFT	5/16" HEX	TIMBER / STEEL ≤3mm	500
RFM635NC5TG	6mm-11TPI X 35mm	THUNDER GREY	5/16" HEX	TIMBER / STEEL ≤3mm	500
RFM635NC5TI	6mm-11TPI X 35mm	TITANIA	5/16" HEX	TIMBER / STEEL ≤3mm	500
RFM635NC5TT	6mm-11TPI X 35mm	TUITUFT	5/16" HEX	TIMBER / STEEL ≤3mm	500
RFM635NC5WG	6mm-11TPI X 35mm	WINDSOR GREY	5/16" HEX	TIMBER / STEEL ≤3mm	500

Other colours available upon request

3 SCREWS FOR METAL

ROOF FAST SCREW

CLASS 5

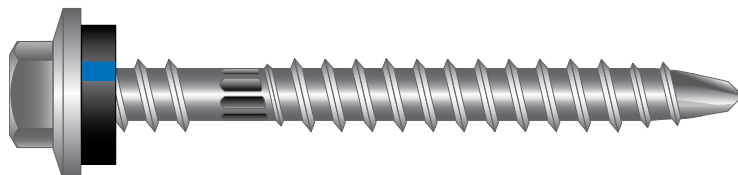

PART #	SIZE	COLOUR	HEAD	STEEL MT(mm)	PACK QTY
RFM655NC5	6mm-11TPI X 55mm	PLAIN	5/16" HEX	TIMBER / STEEL ≤3mm	500
RFM655NC5CL	6mm-11TPI X 55mm	CLOUD	5/16" HEX	TIMBER / STEEL ≤3mm	500
RFM655NC5DS	6mm-11TPI X 55mm	DESERT SAND	5/16" HEX	TIMBER / STEEL ≤3mm	500
RFM655NC5EB	6mm-11TPI X 55mm	EBONY	5/16" HEX	TIMBER / STEEL ≤3mm	500
RFM655NC5FP	6mm-11TPI X 55mm	FLAXPOD	5/16" HEX	TIMBER / STEEL ≤3mm	500
RFM655NC5GF	6mm-11TPI X 55mm	GREY FRIARS	5/16" HEX	TIMBER / STEEL ≤3mm	500
RFM655NC5GG	6mm-11TPI X 55mm	GULL GREY	5/16" HEX	TIMBER / STEEL ≤3mm	500
RFM655NC5IS	6mm-11TPI X 55mm	IRONSAND	5/16" HEX	TIMBER / STEEL ≤3mm	500
RFM655NC5KA	6mm-11TPI X 55mm	KARAKA	5/16" HEX	TIMBER / STEEL ≤3mm	500
RFM655NC5LG	6mm-11TPI X 55mm	LIGNITE	5/16" HEX	TIMBER / STEEL ≤3mm	500
RFM655NC5LI	6mm-11TPI X 55mm	LICHEN	5/16" HEX	TIMBER / STEEL ≤3mm	500
RFM655NC5MG	6mm-11TPI X 55mm	MIST GREEN	5/16" HEX	TIMBER / STEEL ≤3mm	500
RFM655NC5NDB	6mm-11TPI X 55mm	NEW DENIM BLUE	5/16" HEX	TIMBER / STEEL ≤3mm	500
RFM655NC5PG	6mm-11TPI X 55mm	PERMANENT GREEN	5/16" HEX	TIMBER / STEEL ≤3mm	500
RFM655NC5PR	6mm-11TPI X 55mm	PIONEER RED	5/16" HEX	TIMBER / STEEL ≤3mm	500
RFM655NC5SB	6mm-11TPI X 55mm	SANDBAR	5/16" HEX	TIMBER / STEEL ≤3mm	500
RFM655NC5SC	6mm-11TPI X 55mm	SCORIA	5/16" HEX	TIMBER / STEEL ≤3mm	500
RFM655NC5SG	6mm-11TPI X 55mm	SANDSTONE GREY	5/16" HEX	TIMBER / STEEL ≤3mm	500
RFM655NC5SL	6mm-11TPI X 55mm	SLATE	5/16" HEX	TIMBER / STEEL ≤3mm	500
RFM655NC5SP	6mm-11TPI X 55mm	STONEPEAK	5/16" HEX	TIMBER / STEEL ≤3mm	500
RFM655NC5SS	6mm-11TPI X 55mm	SANDSCAPE	5/16" HEX	TIMBER / STEEL ≤3mm	500
RFM655NC5TD	6mm-11TPI X 55mm	TIDALDRIFT	5/16" HEX	TIMBER / STEEL ≤3mm	500
RFM655NC5TG	6mm-11TPI X 55mm	THUNDER GREY	5/16" HEX	TIMBER / STEEL ≤3mm	500
RFM655NC5TI	6mm-11TPI X 55mm	TITANIA	5/16" HEX	TIMBER / STEEL ≤3mm	500
RFM655NC5TT	6mm-11TPI X 55mm	TUITUFT	5/16" HEX	TIMBER / STEEL ≤3mm	500
RFM655NC5WG	6mm-11TPI X 55mm	WINDSOR GREY	5/16" HEX	TIMBER / STEEL ≤3mm	500

Other colours available upon request

ROOF FAST SCREW

CLASS 5

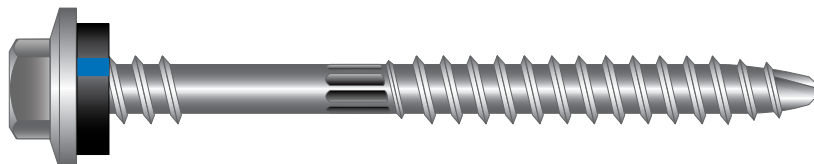

PART #	SIZE	COLOUR	HEAD	STEEL MT(mm)	PACK QTY
RFM665NC5	6mm-11TPI X 65mm	PLAIN	5/16" HEX	TIMBER / STEEL ≤3mm	500
RFM665NC5CL	6mm-11TPI X 65mm	CLOUD	5/16" HEX	TIMBER / STEEL ≤3mm	500
RFM665NC5SDS	6mm-11TPI X 65mm	DESERT SAND	5/16" HEX	TIMBER / STEEL ≤3mm	500
RFM665NC5EB	6mm-11TPI X 65mm	EBONY	5/16" HEX	TIMBER / STEEL ≤3mm	500
RFM665NC5FP	6mm-11TPI X 65mm	FLAXPOD	5/16" HEX	TIMBER / STEEL ≤3mm	500
RFM665NC5GF	6mm-11TPI X 65mm	GREY FRIARS	5/16" HEX	TIMBER / STEEL ≤3mm	500
RFM665NC5GG	6mm-11TPI X 65mm	GULL GREY	5/16" HEX	TIMBER / STEEL ≤3mm	500
RFM665NC5SIS	6mm-11TPI X 65mm	IRONSAND	5/16" HEX	TIMBER / STEEL ≤3mm	500
RFM665NC5KA	6mm-11TPI X 65mm	KARAKA	5/16" HEX	TIMBER / STEEL ≤3mm	500
RFM665NC5LG	6mm-11TPI X 65mm	LICHEN	5/16" HEX	TIMBER / STEEL ≤3mm	500
RFM665NC5LI	6mm-11TPI X 65mm	LICHEN	5/16" HEX	TIMBER / STEEL ≤3mm	500
RFM665NC5MG	6mm-11TPI X 65mm	MIST GREEN	5/16" HEX	TIMBER / STEEL ≤3mm	500
RFM665NC5NDB	6mm-11TPI X 65mm	NEW DENIM BLUE	5/16" HEX	TIMBER / STEEL ≤3mm	500
RFM665NC5PG	6mm-11TPI X 65mm	PERMANENT GREEN	5/16" HEX	TIMBER / STEEL ≤3mm	500
RFM665NC5PR	6mm-11TPI X 65mm	PIONEER RED	5/16" HEX	TIMBER / STEEL ≤3mm	500
RFM665NC5SB	6mm-11TPI X 65mm	SANDBAR	5/16" HEX	TIMBER / STEEL ≤3mm	500
RFM665NC5SC	6mm-11TPI X 65mm	SCORIA	5/16" HEX	TIMBER / STEEL ≤3mm	500
RFM665NC5SG	6mm-11TPI X 65mm	SANDSTONE GREY	5/16" HEX	TIMBER / STEEL ≤3mm	500
RFM665NC5SL	6mm-11TPI X 65mm	SLATE	5/16" HEX	TIMBER / STEEL ≤3mm	500
RFM665NC5SP	6mm-11TPI X 65mm	STONEPEAK	5/16" HEX	TIMBER / STEEL ≤3mm	500
RFM665NC5SS	6mm-11TPI X 65mm	SANDSCAPE	5/16" HEX	TIMBER / STEEL ≤3mm	500
RFM665NC5STD	6mm-11TPI X 65mm	TIDALDRIFT	5/16" HEX	TIMBER / STEEL ≤3mm	500
RFM665NC5TG	6mm-11TPI X 65mm	THUNDER GREY	5/16" HEX	TIMBER / STEEL ≤3mm	500
RFM665NC5TI	6mm-11TPI X 65mm	TITANIA	5/16" HEX	TIMBER / STEEL ≤3mm	500
RFM665NC5TT	6mm-11TPI X 65mm	TUITUFT	5/16" HEX	TIMBER / STEEL ≤3mm	500
RFM665NC5SWG	6mm-11TPI X 65mm	WINDSOR GREY	5/16" HEX	TIMBER / STEEL ≤3mm	500

Other colours available upon request

3 SCREWS FOR METAL

WINGTEK SDS SCREW

ZINC CHROMATE CLASS 4



PART #	PART #	SIZE	SQUARE	MT(mm)	PACK QTY
TKCWQ1035C2	TKCWQ1035C4	10-16 X 35mm	#2	0.75-3.50	200
TKCWQ1045C2	TKCWQ1045C4	10-16 X 45mm	#2	0.75-3.50	200
TKCWQ1050C2	TKCWQ1050C4	10-16 X 50mm	#2	0.75-3.50	100
TKCWQ1060C2	TKCWQ1065C4	10 -16 X 60/65mm	#2	0.75-3.50	100
TKCWQ1075C2	TKCWQ1075C4	10-16 X 75mm	#2	0.75-3.50	100

SDS SELF EMBED SCREW

ZINC CHROMATE

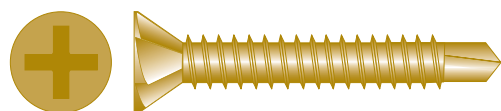

PART #	SIZE	PHILLIPS	MT(mm)	PACK QTY
TKCR820C2	8G X 20mm	#2	0.75-2.50	1000
TKCR825C2	8G X 25mm	#2	0.75-2.50	1000
TKCR830C2	8G X 30mm	#2	0.75-2.50	1000

SDS WAFER SCREW PHILIPS

ZINC CHROMATE CLASS 4

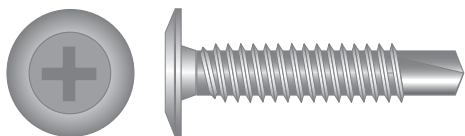

PART #	PART #	SIZE	PHILLIPS	PACK QTY
TKW1016C2	TKW1016C4	10G X 16	#2	1000
TKW1022C2	TKW1022C4	10G X 22	#2	1000
TKW1030C2	TKW1030C4	10G X 30	#2	1000

SDS WAFER SCREW SQUARE

ZINC CHROMATE CLASS 4

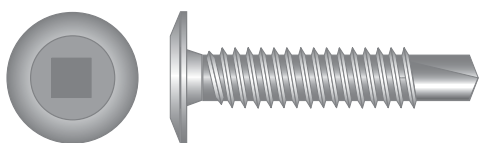

PART #	PART #	SIZE	SQUARE	PACK QTY
TKWQ812C2		8G X 12	#2	1000
TKWQ1016C2	TKWQ1016C4	10G X 16	#2	1000
TKWQ1022C2	TKWQ1022C4	10G X 22	#2	1000
	TKWQ1025C4	10G X 25	#2	1000
TKWQ1030C2	TKWQ1030C4	10G X 30	#2	1000

3 SCREWS FOR METAL

SDS BUTTON SCREW

ZINC CHROMATE

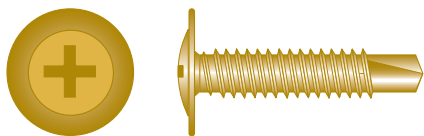

PART #	SIZE	PHILLIPS	PACK QTY
TKWB812C2	8G X 12	#2	1000
TKWB816C2	8G X 16	#2	1000
TKWB820C2	8G X 20	#2	1000
TKWB825C2	8G X 25	#2	1000

SKARA SCREWS - REAMER

CLASS 3

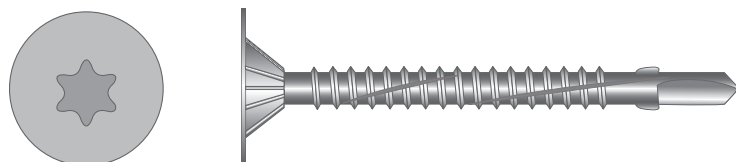

PART #	SIZE	TORX	PACK QTY
TKCWT1455C3	14G X 55mm	T-30	50
TKCWT1465C3	14G X 65mm	T-30	50
TKCWT1480C3	14G X 80mm	T-30	50
TKCWT14110C3	14G X 110mm	T-30	50
TKCWT14130C3	14G X 130mm	T-30	50

SELF TAPPING SCREWS

SPECIFICATIONS

Materials:
 Steel C1022
 Stainless grade 304 passivated and waxed

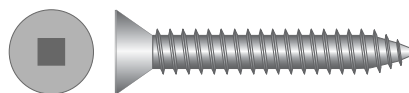
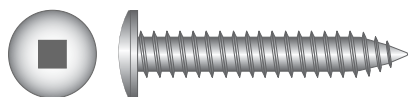

SPECIFICATIONS

THREAD DIAMETER	4G		TORSIONAL STRENGTH		STEEL	STAINLESS
	2.85mm					
	6G	3.5mm				
	8G	4.2mm		4G	2.5 NM	2.2 NM
	10G	4.8mm		6G	3.5 NM	3.0 NM
	12G	5.4mm		8G	6.4 NM	3.8 NM
	14G	6.4mm		10G	10.0 NM	6.0 NM

DRILL SIZES FOR SELF TAPPING SCREWS

SCREW SIZE	MATERIAL THICKNESS (mm)	RECOmmENDED PILOT HOLE SIZE (mm)	
4G (2.85mm)	1.00	2.30	
	2.00	2.60	
6G (3.5mm)	1.00	2.80	
	2.50	3.20	
8G (4.2mm)	1.00	3.10	
	2.00	3.50	
	3.00	3.80	
10G (4.8mm)	1.00	3.50	
	2.50	4.00	
	4.50	4.40	
12G (5.4mm)	2.00	4.60	
	3.00	4.90	
	5.00	5.10	
14G (6.4mm)	3.00	5.70	
	6.50	6.00	

3 SCREWS FOR METAL

SELF TAPPING SCREWS - CSK SQUARE DRIVE

STAINLESS STEEL T304

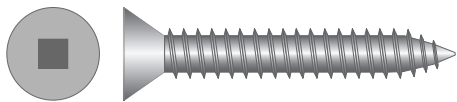

PACK #	JAR #	SIZE	SQUARE	PACK QTY	JAR QTY
STCQX412		4G X 12	#1	1000	
STCQX420		4G X 20	#1	1000	
STCQX610		6G X 10	#1	1000	
STCQX612	STCQX612J	6G X 12	#1	1000	200
STCQX616	STCQX616J	6G X 16	#1	1000	200
STCQX620	STCQX620J	6G X 20	#1	1000	200
STCQX625	STCQX625J	6G X 25	#1	1000	200
STCQX632	STCQX632J	6G X 32	#1	1000	200
STCQX640	STCQX640J	6G X 40	#1	1000	200
STCQX650		6G X 50	#1	1000	
STCQX810		8G X 10	#1	1000	
STCQX812	STCQX812J	8G X 12	#1	1000	200
STCQX816	STCQX816J	8G X 16	#1	1000	200
STCQX820	STCQX820J	8G X 20	#1	1000	200
STCQX825	STCQX825J	8G X 25	#1	1000	200
STCQX832	STCQX832J	8G X 32	#1	1000	200
STCQX840	STCQX840J	8G X 40	#1	1000	200
STCQX850	STCQX850J	8G X 50	#1	500	100
STCQX865		8G X 65	#1	500	
STCQX875		8G X 75	#1	500	
STCQX1012	STCQX1012J	10G X 12	#1	1000	200
STCQX1020	STCQX1020J	10G X 20	#1	1000	200
STCQX1025	STCQX1025J	10G X 25	#1	1000	200
STCQX1032	STCQX1032J	10G X 32	#1	1000	200
STCQX1040		10G X 40	#1	500	
STCQX1050	STCQX1050J	10G X 50	#1	500	100
STCQX1065		10G X 65	#1	200	
STCQX1075		10G X 75	#1	200	

SELF TAPPING SCREWS - CSK SQUARE DRIVE

STAINLESS STEEL T304 - #2 DRIVE

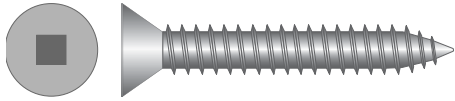

PACK #	SIZE	SQUARE	PACK QTY
STCQX810#2	8G X 10	#2	1000
STCQX812#2	8G X 12	#2	1000
STCQX816#2	8G X 16	#2	1000
STCQX820#2	8G X 20	#2	1000
STCQX825#2	8G X 25	#2	1000
STCQX832#2	8G X 32	#2	1000
STCQX840#2	8G X 40	#2	1000
STCQX850#2	8G X 50	#2	1000
STCQX865#2	8G X 65	#2	1000
STCQX875#2	8G X 75	#2	1000

STAINLESS STEEL T304 - T17 POINT

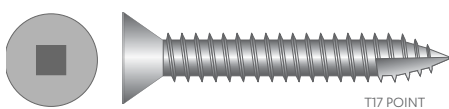

PART #	SIZE	SQUARE	PACK QTY
STCQX625T17	6G X 25	#1	1000
STCQX850T17	8G X 50	#1	500
STCQX1040T17	10G X 40	#1	500

3 SCREWS FOR METAL

SELF TAPPING SCREWS - CSK SQUARE DRIVE

STAINLESS STEEL T304 - TRUNCATED HEAD

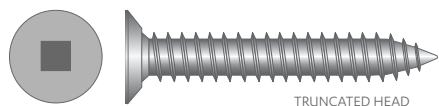

PART #	SIZE	PACK QTY
STCQX810TR	8G X 10	1000
STCQX812TR	8G X 12	1000
STCQX820TR	8G X 20	1000
STCQX1012TR	10G X 12	1000
STCQX1020TR	10G X 20	1000
STCQX1025TR	10G X 25	1000
STCQX1040TR	10G X 40	500

SELF TAPPING SCREWS - PAN SQUARE DRIVE

STAINLESS STEEL T304 - LEAD POINT

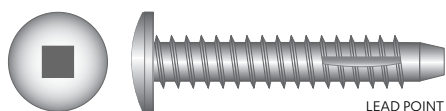

PACK #	SIZE	SQUARE	PACK QTY
STPQX620L	6G X 20mm	#1	1000
STPQX625L	6G X 25mm	#1	1000
STPQX632L	6G X 32mm	#1	1000
STPQX650L	6G X 50mm	#1	1000
STPQX825L	8G X 25mm	#1	1000
STPQX850L	8G X 50mm	#1	500

SELF TAPPING SCREWS - PAN SQUARE DRIVE

STAINLESS STEEL T304

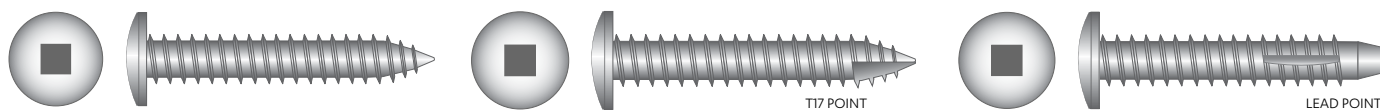

PACK #	JAR #	SIZE	SQUARE	PACK QTY	JAR QTY
STPQX66		6G X 6mm	#0	1000	
STPQX610	STPQX610J	6G X 10mm	#0	1000	200
STPQX612	STPQX612J	6G X 12mm	#1	1000	200
STPQX616	STPQX616J	6G X 16mm	#1	1000	200
STPQX620	STPQX620J	6G X 20mm	#1	1000	200
STPQX625	STPQX625J	6G X 25mm	#1	1000	200
STPQX632	STPQX632J	6G X 32mm	#1	1000	200
STPQX640	STPQX640J	6G X 40mm	#1	1000	200
STPQX650	STPQX650J	6G X 50mm	#1	1000	200
STPQX812	STPQX812J	8G X 12mm	#1	1000	200
STPQX816	STPQX816J	8G X 16mm	#1	1000	200
STPQX820	STPQX820J	8G X 20mm	#1	1000	200
STPQX825	STPQX825J	8G X 25mm	#1	1000	200
STPQX832	STPQX832J	8G X 32mm	#1	1000	200
STPQX840	STPQX840J	8G X 40mm	#1	1000	200
STPQX850	STPQX850J	8G X 50mm	#1	500	100
STPQX865		8G X 65mm	#1	500	
STPQX875		8G X 75mm	#1	200	
STPQX1012	STPQX1012J	10G X 12mm	#1	1000	200
STPQX1016	STPQX1016J	10G X 16mm	#1	1000	200
STPQX1020	STPQX1020J	10G X 20mm	#1	1000	200
STPQX1025	STPQX1025J	10G X 25mm	#1	1000	200
STPQX1032	STPQX1032J	10G X 32mm	#1	1000	200
STPQX1040	STPQX1040J	10G X 40mm	#1	500	100
STPQX1050		10G X 50mm	#1	500	
STPQX1065		10G X 65mm	#1	500	
STPQX1075		10G X 75mm	#1	200	
STPQX1225#3		12G X 25mm	#3	500	
STPQX1232#3		12G X 32mm	#3	500	
STPQX1240#3		12G X 40mm	#3	500	
STPQX1250#3		12G X 50mm	#3	500	
STPQX1265#3		12G X 65mm	#3	500	
STPQX1275#3		12G X 75mm	#3	500	

3 SCREWS FOR METAL

SELF TAPPING SCREWS - PAN SQUARE DRIVE

STAINLESS STEEL T304- #2 DRIVE

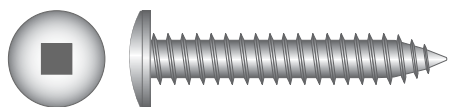

PART #	SIZE	SQUARE	PACK QTY
STPQX812#2	8G X 12mm	#2	1000
STPQX816#2	8G X 16mm	#2	1000
STPQX820#2	8G X 20mm	#2	1000
STPQX825#2	8G X 25mm	#2	1000
STPQX832#2	8G X 32mm	#2	1000
STPQX840#2	8G X 40mm	#2	1000
STPQX850#2	8G X 50mm	#2	500
STPQX865#2	8G X 65mm	#2	500
STPQX875#2	8G X 75mm	#2	200

SELF TAPPING SCREWS - PAN SQUARE DRIVE

STAINLESS STEEL T304 - T17 POINT

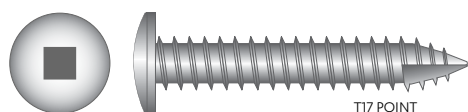

PART #	SIZE	SQUARE	PACK QTY
STPQX612T17	6G X 12mm	#1	1000
STPQX620T17	6G X 20mm	#1	1000
STPQX625T17	6G X 25mm	#1	1000
STPQX632T17	6G X 32mm	#1	1000
STPQX640T17	6G X 40mm	#1	1000
STPQX650T17	6G X 50mm	#1	1000
STPQX832T17	8G X 32mm	#1	1000

SELF TAPPING SCREWS - PAN POZI

ZINC PLATED

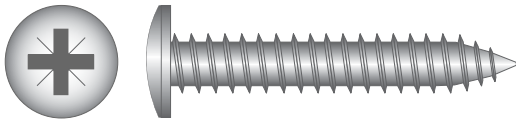

PACK #	JAR #	SIZE	PACK QTY	JAR QTY
STPP46Z		4G X 6	1000	
STPP410Z	STPP410ZJ	4G X 10	1000	200
STPP412Z	STPP412ZJ	4G X 12	1000	200
STPP416Z	STPP416ZJ	4G X 16	1000	200
STPP420Z	STPP420ZJ	4G X 20	1000	200
STPP425Z		4G X 25	1000	
STPP66Z		6G X 6	1000	
STPP610Z	STPP610ZJ	6G X 10	1000	200
STPP612Z	STPP612ZJ	6G X 12	1000	200
STPP616Z	STPP616ZJ	6G X 16	1000	200
STPP620Z	STPP620ZJ	6G X 20	1000	200
STPP625Z	STPP625ZJ	6G X 25	1000	200
STPP632Z	STPP632ZJ	6G X 32	1000	200
STPP640Z	STPP640ZJ	6G X 40	1000	200
STPP810Z	STPP810ZJ	8G X 10	1000	200
STPP812Z	STPP812ZJ	8G X 12	1000	200
STPP816Z	STPP816ZJ	8G X 16	1000	200
STPP820Z	STPP820ZJ	8G X 20	1000	200
STPP825Z	STPP825ZJ	8G X 25	1000	200

PACK #	JAR #	SIZE	PACK QTY	JAR QTY
STPP832Z	STPP832ZJ	8G X 32	1000	200
STPP840Z	STPP840ZJ	8G X 40	1000	200
STPP845Z	STPP845ZJ	8G X 45	1000	100
STPP850Z		8G X 50	500	
STPP1010Z		10G X 10	1000	
STPP1012Z	STPP1012ZJ	10G X 12	1000	200
STPP1016Z	STPP1016ZJ	10G X 16	1000	200
STPP1020Z	STPP1020ZJ	10G X 20	1000	200
STPP1025Z	STPP1025ZJ	10G X 25	1000	200
STPP1032Z	STPP1032ZJ	10G X 32	500	200
STPP1040Z	STPP1040ZJ	10G X 40	500	100
STPP1050Z	STPP1050ZJ	10G X 50	500	100
STPP1220Z	STPP1220ZJ	12G X 20	1000	200
STPP1225Z	STPP1225ZJ	12G X 25	1000	200
STPP1232Z	STPP1232ZJ	12G X 32	1000	100
STPP1240Z	STPP1240ZJ	12G X 40	500	100
STPP1250Z	STPP1250ZJ	12G X 50	500	100
STPP1265Z		12G X 65	500	

3 SCREWS FOR METAL

SELF TAPPING SCREWS - CSK POZI

ZINC PLATED

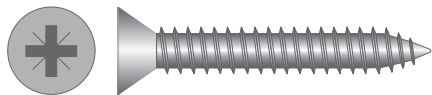

PACK #	SIZE	POZI	PACK QTY
STCP412Z	4G X 12	#1	1000
STCP610Z	6G X 10	#1	1000
STCP612Z	6G X 12	#1	1000
STCP616Z	6G X 16	#1	1000
STCP620Z	6G X 20	#1	1000
STCP625Z	6G X 25	#1	1000
STCP640Z	6G X 40	#1	1000
STCP820Z	8G X 20	#2	1000
STCP825Z	8G X 25	#2	1000
STCP832Z	8G X 32	#2	1000
STCP840Z	8G X 40	#2	1000
STCP1020Z	10G X 20	#2	1000

PACK #	SIZE	POZI	PACK QTY
STCP1025Z	10G X 25	#2	1000
STCP1040Z	10G X 40	#2	1000
STCP1050Z	10G X 50	#2	500
STCP1075Z	10G X 75	#2	500
STCP1225Z	12G X 25	#3	1000
STCP1232Z	12G X 32	#3	1000
STCP1240Z	12G X 40	#3	500
STCP1250Z	12G X 50	#3	500
STCP1265Z	12G X 65	#3	500
STCP1275Z	12G X 75	#3	500
STCP1432Z	14G X 32	#3	500

CSK SELF DRILLING SCREWS - BLACK

STAINLESS STEEL T410

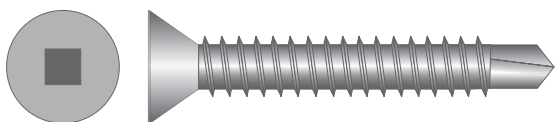

PART #	SIZE	SQUARE	PACK QTY
TKCQXM411BLK	M4 X11	#1	1000
TKCQXM414BLK	M4 X 14	#1	1000
TKCQXM416BLK	M4 X 16	#1	1000
TKCQXM420BLK	M4 X 20	#1	1000
TKCQXM515BLK	M5 X 15	#1	1000
TKCQXM517BLK	M5 X 17	#1	1000
TKCQX812BLK	8G X 12	#1	1000

CSK SELF DRILLING SCREWS

STAINLESS STEEL T410

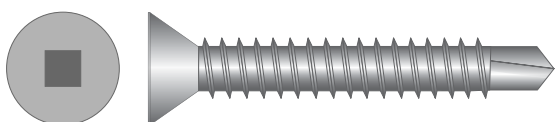

PART #	SIZE	FINISH	PACK QTY
TKCQX812	8-32 X 12	PLAIN	1000
TKCQX812BLK	8-32 X 12	BLACK	1000

3 SCREWS FOR METAL

RAISED CSK SELF TAPPING SCREWS TYPE B

STAINLESS STEEL T304

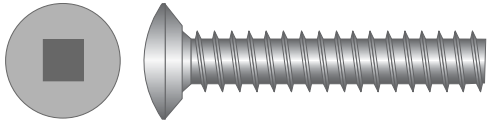

PART #	SIZE	FINISH	PACK QTY
STRQX810TR	8G X 10	PLAIN	1000
STRQX810BLK	8G X 10	BLACK	1000

TRUCK DECK SCREWS

ZINC PLATED

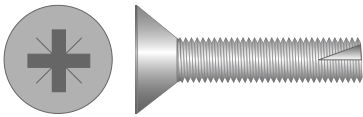

PART #	SIZE	PACK QTY
MCPHM625D	M6 X 25	100
MCPHM635D	M6 X 35	100
MCPHM645D	M6 X 45	100
MCPHM650D	M6 X 50	100
MCPHM655D	M6 X 55	100
MCPHM665D	M6 X 65	100

TRUNC SELF TAPPING SCREWS

STAINLESS STEEL T304

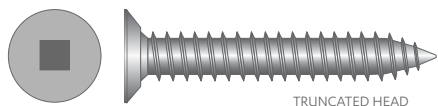

PART #	SIZE	PACK QTY
STCQX810TR	8G X 10	1000
STCQX812TR	8G X 12	1000
STCQX820TR	8G X 20	1000
STCQX1012TR	10G X 12	1000
STCQX1020TR	10G X 20	1000
STCQX1025TR	10G X 25	1000
STCQX1040TR	10G X 40	500

3 SCREWS FOR METAL

MACHINE SCREWS

ZINC PLATED - PAN POZI

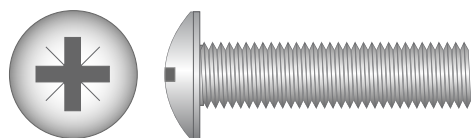

PACK #	SIZE	PACK QTY
MPPM36Z	M3 X 6	200
MPPM38Z	M3 X 8	200
MPPM310Z	M3 X 10	200
MPPM312Z	M3 X 12	200
MPPM316Z	M3 X 16	200
MPPM320Z	M3 X 20	200
MPPM325Z	M3 X 25	200
MPPM330Z	M3 X 30	200
MPPM335Z	M3 X 35	200
MPPM340Z	M3 X 40	200
MPPM46Z	M4 X 6	200
MPPM48Z	M4 X 8	200
MPPM410Z	M4 X 10	200
MPPM412Z	M4 X 12	200
MPPM416Z	M4 X 16	200
MPPM420Z	M4 X 20	200
MPPM425Z	M4 X 25	200
MPPM430Z	M4 X 30	200
MPPM435Z	M4 X 35	200
MPPM440Z	M4 X 40	200
MPPM445Z	M4 X 45	200
MPPM450Z	M4 X 50	200
MPPM56Z	M5 X 6	200
MPPM58Z	M5 X 8	200
MPPM510Z	M5 X 10	200

PACK #	SIZE	PACK QTY
MPPM512Z	M5 X 12	200
MPPM516Z	M5 X 16	200
MPPM520Z	M5 X 20	200
MPPM525Z	M5 X 25	200
MPPM530Z	M5 X 30	200
MPPM535Z	M5 X 35	200
MPPM540Z	M5 X 40	200
MPPM545Z	M5 X 45	200
MPPM550Z	M5 X 50	200
MPPM610Z	M6 X 10	200
MPPM612Z	M6 X 12	200
MPPM616Z	M6 X 16	200
MPPM620Z	M6 X 20	200
MPPM625Z	M6 X 25	200
MPPM630Z	M6 X 30	200
MPPM635Z	M6 X 35	200
MPPM640Z	M6 X 40	200
MPPM650Z	M6 X 50	200
MPPM816Z	M8 X 16	200
MPPM820Z	M8 X 20	200
MPPM825Z	M8 X 25	200
MPPM830Z	M8 X 30	200
MPPM840Z	M8 X 40	200
MPPM850Z	M8 X 50	200

MACHINE SCREWS

ZINC PLATED - CSK SLOT

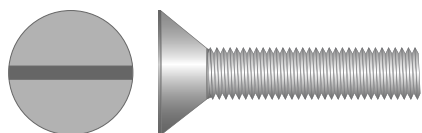

PACK #	SIZE	PACK QTY
MCSM312Z	M3 X 12	100
MCSM320Z	M3 X 20	100
MCSM325Z	M3 X 25	100
MCSM46Z	M4 X 6	100
MCSM48Z	M4 X 8	100
MCSM410Z	M4 X 10	100
MCSM412Z	M4 X 12	100
MCSM416Z	M4 X 16	100
MCSM420Z	M4 X 20	100
MCSM430Z	M4 X 30	100
MCSM440Z	M4 X 40	100
MCSM58Z	M5 X 8	100
MCSM510Z	M5 X 10	100
MCSM512Z	M5 X 12	100
MCSM516Z	M5 X 16	100
MCSM525Z	M5 X 25	100
MCSM530Z	M5 X 30	100
MCSM540Z	M5 X 40	100
MCSM612Z	M6 X 12	100
MCSM616Z	M6 X 16	100
MCSM620Z	M6 X 20	100
MCSM625Z	M6 X 25	100
MCSM630Z	M6 X 30	100
MCSM640Z	M6 X 40	100
MCSM650Z	M6 X 50	100
MCSM665Z	M6 X 65	100

ZINC PLATED - CSK POZI

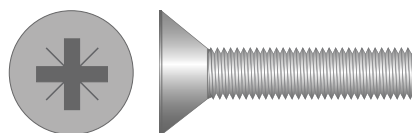

PACK #	SIZE	PACK QTY
MCPM256Z	M2.5 X 6	200
MCPM2510Z	M2.5 X 10	200
MCPM36Z	M3 X 6	200
MCPM38Z	M3 X 8	200
MCPM310Z	M3 X 10	200
MCPM312Z	M3 X 12	200
MCPM316Z	M3 X 16	200
MCPM320Z	M3 X 20	200
MCPM46Z	M4 X 6	200
MCPM48Z	M4 X 8	200
MCPM410Z	M4 X 10	200
MCPM412Z	M4 X 12	200
MCPM416Z	M4 X 16	200
MCPM420Z	M4 X 20	200
MCPM425Z	M4 X 25	200
MCPM510Z	M5 X 10	200
MCPM512Z	M5 X 12	200
MCPM516Z	M5 X 16	200
MCPM525Z	M5 X 25	200
MCPM535Z	M5 X 35	200
MCPM540Z	M5 X 40	200
MCPM550Z	M5 X 50	200
MCPM616Z	M6 X 16	200
MCPM620Z	M6 X 20	200
MCPM625Z	M6 X 25	200
MCPM630Z	M6 X 30	200
MCPM635Z	M6 X 35	200
MCPM640Z	M6 X 40	200
MCPM650Z	M6 X 50	200
MCPM825Z	M8 X 25	200
MCPM830Z	M8 X 30	200
MCPM840Z	M8 X 40	200

3 SCREWS FOR METAL

MACHINE SCREWS

ZINC PLATED - PAN SLOT

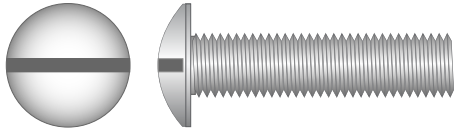

PACK #	SIZE	PACK QTY
MPSM320Z	M3 X 20	100
MPSM325Z	M3 X 25	100
MPSM330Z	M3 X 30	100
MPSM335Z	M3 X 35	100
MPSM340Z	M3 X 40	100
MPSM350Z	M3 X 50	100
MPSM46Z	M4 X 6	100
MPSM48Z	M4 X 8	100
MPSM410Z	M4 X 10	100
MPSM412Z	M4 X 12	100
MPSM416Z	M4 X 16	100
MPSM420Z	M4 X 20	100
MPSM425Z	M4 X 25	100
MPSM430Z	M4 X 30	100
MPSM435Z	M4 X 35	100
MPSM440Z	M4 X 40	100
MPSM450Z	M4 X 50	100
MPSM58Z	M5 X 8	100
MPSM510Z	M5 X 10	100

PACK #	SIZE	PACK QTY
MPSM512Z	M5 X 12	100
MPSM516Z	M5 X 16	100
MPSM520Z	M5 X 20	100
MPSM530Z	M5 X 30	100
MPSM535Z	M5 X 35	100
MPSM540Z	M5 X 40	100
MPSM550Z	M5 X 50	100
MPSM610Z	M6 X 10	100
MPSM612Z	M6 X 12	100
MPSM616Z	M6 X 16	100
MPSM620Z	M6 X 20	100
MPSM630Z	M6 X 30	100
MPSM635Z	M6 X 35	100
MPSM640Z	M6 X 40	100
MPSM645Z	M6 X 45	100
MPSM650Z	M6 X 50	100
MPSM675Z	M6 X 75	100
MPSM820Z	M8 X 20	100
MPSM825Z	M8 X 25	100

MACHINE SCREWS

IMPERIAL - ZINC PLATED - PAN SLOT

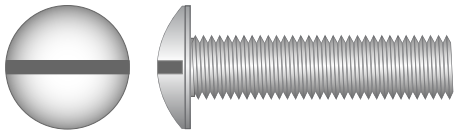

PACK #	SIZE	PACK QTY
MRS18112Z	1/8 X 1 1/2"	100
MRS1812Z	1/8 X 1/2"	100
MRS1814Z	1/8 X 1/4"	100
MRS181Z	1/8 X 1"	100
MRS1834Z	1/8 X 3/4"	100
MRS1838Z	1/8 X 3/8"	100
MRS1858Z	1/8 X 5/8"	100
MRS532112Z	5/32 X 1 1/2"	100
MRS53214Z	5/32 X 1 1/4"	100
MRS53212Z	5/32 X 1/2"	100
MRS532134Z	5/32 X 1 3/4"	100
MRS53214Z	5/32 X 1/4"	100
MRS5321Z	5/32 X 1"	100
MRS5322Z	5/32 X 2"	100
MRS31612Z	3/16 X 1/2"	100
MRS316134Z	3/16 X 1 3/4"	100
MRS31614Z	3/16 X 1/4"	100

PACK #	SIZE	PACK QTY
MRS3161Z	3/16 X 1"	100
MRS316212Z	3/16 X 2 1/2"	100
MRS3162Z	3/16 X 2"	100
MRS31634Z	3/16 X 3/4"	100
MRS31638Z	3/16 X 3/8"	100
MRS3163Z	3/16 X 3"	100
MRS31658Z	3/16 X 5/8"	100
MRS14112Z	1/4 X 1 1/2"	100
MRS14114Z	1/4 X 1 1/4"	100
MRS1412Z	1/4 X 1/2"	100
MRS141Z	1/4 X 1"	100
MRS14214Z	1/4 X 2 1/4"	100
MRS142Z	1/4 X 2"	100
MRS1434Z	1/4 X 3/4"	100
MRS5161Z	5/16 X 1"	100
MRS5162Z	5/16 X 2"	100

3 SCREWS FOR METAL

MACHINE SCREWS

STAINLESS STEEL T304 - CSK PHILIPS

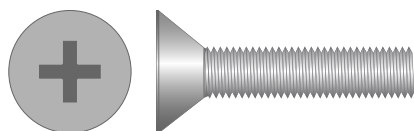

PACK #	SIZE	PACK QTY
MCPHXM2512	M2.5 X 12	200
MCPHXM36	M3 X 6	200
MCPHXM38	M3 X 8	200
MCPHXM310	M3 X 10	200
MCPHXM312	M3 X 12	200
MCPHXM316	M3 X 16	200
MCPHXM320	M3 X 20	200
MCPHXM325	M3 X 25	200
MCPHXM330	M3 X 30	200
MCPHXM48	M4 X 8	200
MCPHXM410	M4 X 10	200
MCPHXM412	M4 X 12	200
MCPHXM416	M4 X 16	200
MCPHXM420	M4 X 20	200
MCPHXM425	M4 X 25	200
MCPHXM430	M4 X 30	200
MCPHXM435	M4 X 35	200
MCPHXM440	M4 X 40	200
MCPHXM450	M4 X 50	200

PACK #	SIZE	PACK QTY
MCPHXM58	M5 X 8	200
MCPHXM510	M5 X 10	200
MCPHXM512	M5 X 12	200
MCPHXM516	M5 X 16	200
MCPHXM520	M5 X 20	200
MCPHXM525	M5 X 25	200
MCPHXM530	M5 X 30	200
MCPHXM535	M5 X 35	200
MCPHXM540	M5 X 40	200
MCPHXM550	M5 X 50	200
MCPHXM610	M6 X 10	200
MCPHXM612	M6 X 12	200
MCPHXM616	M6 X 16	200
MCPHXM620	M6 X 20	200
MCPHXM625	M6 X 25	200
MCPHXM630	M6 X 30	200
MCPHXM635	M6 X 35	200
MCPHXM640	M6 X 40	100
MCPHXM650	M6 X 50	100

MACHINE SCREWS

STAINLESS STEEL T304 - PAN PHILIPS

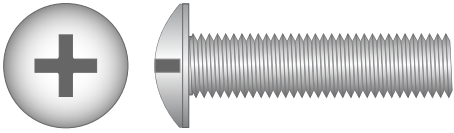

PACK #	SIZE	PACK QTY
MPPHXM210	M2 X 10	200
MPPHXM258	M2.5 X 8	200
MPPHXM36	M3 X 6	200
MPPHXM38	M3 X 8	200
MPPHXM310	M3 X 10	200
MPPHXM312	M3 X 12	200
MPPHXM316	M3 X 16	200
MPPHXM320	M3 X 20	200
MPPHXM330	M3 X 30	200
MPPHXM340	M3 X 40	200
MPPHXM350	M3 X 50	200
MPPHXM46	M4 X 6	200
MPPHXM48	M4 X 8	200
MPPHXM410	M4 X 10	200
MPPHXM412	M4 X 12	200
MPPHXM416	M4 X 16	200
MPPHXM420	M4 X 20	200
MPPHXM425	M4 X 25	200
MPPHXM430	M4 X 30	200

PACK #	SIZE	PACK QTY
MPPHXM440	M4 X 40	200
MPPHXM510	M5 X 10	200
MPPHXM512	M5 X 12	200
MPPHXM516	M5 X 16	200
MPPHXM520	M5 X 20	200
MPPHXM530	M5 X 30	200
MPPHXM550	M5 X 50	200
MPPHXM68	M6 X 8	200
MPPHXM610	M6 X 10	200
MPPHXM612	M6 X 12	200
MPPHXM616	M6 X 16	200
MPPHXM620	M6 X 20	200
MPPHXM625	M6 X 25	200
MPPHXM630	M6 X 30	200
MPPHXM635	M6 X 35	200
MPPHXM640	M6 X 40	100
MPPHXM650	M6 X 50	100

3 SCREWS FOR METAL

MACHINE SCREWS

STAINLESS STEEL T304 - CHEESE SLOT

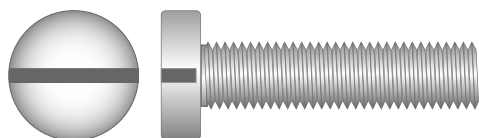

PACK #	SIZE	PACK QTY
MCHSXM255	M2.5 X 5	200
MCHSXM36	M3 X 6	200
MCHSXM38	M3 X 8	200
MCHSXM310	M3 X 10	200
MCHSXM420	M4 X 20	200

PACK #	SIZE	PACK QTY
MCHSXM430	M4 X 30	200
MCHSXM510	M5 X 10	200
MCHSXM525	M5 X 25	200
MCHSXM625	M6 X 25	200

MACHINE SCREWS

STAINLESS STEEL T304 - PAN SLOT

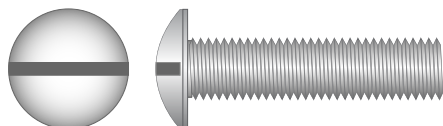

PACK #	SIZE	PACK QTY
MPSXM38	M3 X 8	100
MPSXM310	M3 X 10	100
MPSXM312	M3 X 12	100
MPSXM316	M3 X 16	100
MPSXM320	M3 X 20	100
MPSXM325	M3 X 25	100
MPSXM330	M3 X 30	100
MPSXM48	M4 X 8	100
MPSXM410	M4 X 10	100
MPSXM416	M4 X 16	100
MPSXM420	M4 X 20	100
MPSXM425	M4 X 25	100
MPSXM430	M4 X 30	100
MPSXM510	M5 X 10	100

PACK #	SIZE	PACK QTY
MPSXM512	M5 X 12	100
MPSXM516	M5 X 16	100
MPSXM520	M5 X 20	100
MPSXM525	M5 X 25	100
MPSXM530	M5 X 30	100
MPSXM540	M5 X 40	100
MPSXM612	M6 X 12	100
MPSXM616	M6 X 16	100
MPSXM620	M6 X 20	100
MPSXM625	M6 X 25	100
MPSXM630	M6 X 30	100
MPSXM812	M8 X 12	100
MPSXM816	M8 X 16	100
MPSXM830	M8 X 30	100

MACHINE SCREWS

STAINLESS STEEL T304 - CSK SLOT IMPERIAL - ZINC PLATED - CSK SLOT

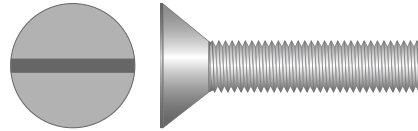
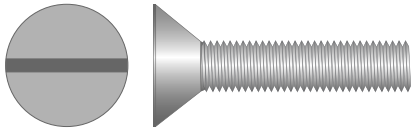

PACK #	SIZE	PACK QTY
MCSXM310	M3 X 10	200
MCSXM48	M4 X 8	200
MCSXM410	M4 X 10	200
MCSXM412	M4 X 12	200
MCSXM416	M4 X 16	200
MCSXM420	M4 X 20	200
MCSXM425	M4 X 25	200
MCSXM450	M4 X 50	200
MCSXM510	M5 X 10	200
MCSXM512	M5 X 12	200
MCSXM516	M5 X 16	200
MCSXM520	M5 X 20	200
MCSXM525	M5 X 25	200
MCSXM530	M5 X 30	200
MCSXM540	M5 X 40	200
MCSXM610	M6 X 10	200
MCSXM612	M6 X 12	200
MCSXM616	M6 X 16	200
MCSXM620	M6 X 20	200
MCSXM625	M6 X 25	200
MCSXM630	M6 X 30	200
MCSXM640	M6 X 40	200
MCSXM650	M6 X 50	200
MCSXM820	M8 X 20	100
MCSXM825	M8 X 25	100
MCSXM830	M8 X 30	100
MCSXM840	M8 X 40	100
MCSXM850	M8 X 50	100
MCSXM1025	M10 X 25	100
MCSXM1030	M10 X 30	100
MCSXM1040	M10 X 40	100
MCSXM1050	M10 X 50	100

PACK #	SIZE	PACK QTY
MCS181Z	1/8 X 1"	100
MCS532112Z	5/32 X 1 1/2"	100
MCS532114Z	5/32 X 1 1/4"	100
MCS53214Z	5/32 X 1/4"	100
MCS5321Z	5/32 X 1"	100
MCS5322Z	5/32 X 2"	100
MCS53234Z	5/32 X 3/4"	100
MCS316112Z	3/16 X 1 1/2"	100
MCS316114Z	3/16 X 1 1/4"	100
MCS316Z1Z	3/16 X 1"	100
MCS31634Z	3/16 X 3/4"	100
MCS31658Z	3/16 X 5/8"	100
MCS14114Z	1/4 X 1 1/4"	100
MCS142Z	1/4 X 2"	100

3 SCREWS FOR METAL

MACHINE SCREWS

IMPERIAL - STAINLESS STEEL T304
- RND SLOT

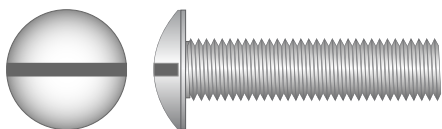

PACK #	SIZE	PACK QTY
MRSX53214	5/32 X 1/4"	100
MRSX532114	5/32 X 1 1/4"	100
MRSX181	1/8 X 1/4"	100
MRSX1	1/8 X 1"	100
MRSX31612	3/16 X 1/2"	100
MRSX31658	3/16 X 5/8"	100
MRSX31634	3/16 X 3/4"	100
MRSX3162	3/16 X 2"	100
MRSX316212	3/16 X 2 1/2"	100
MRSX3163	3/16 X 3"	100

PACK #	SIZE	PACK QTY
MRSX1434	1/4 X 3/4"	100
MRSX14114	1/4 X 1 1/4"	100
MRSX14112	1/4 X 1 1/2"	100
MRSX142	1/4 X 2"	100
MRSX143	1/4 X 3"	100
MRSX5161	5/16 X 1"	100
MRSX5162	5/16 X 2"	100
MRSX516212	5/16 X 2 1/2"	100
MRSX5163	5/16 X 3"	100

MACHINE SCREWS

IMPERIAL - STAINLESS STEEL T304 - CSK PHILIPS

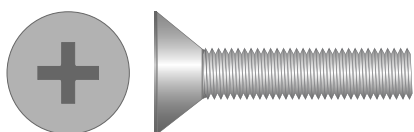

PACK #	SIZE	PACK QTY
MCPHX31614	3/16 X 1/4"	100
MCPHX31638	3/16 X 3/8"	100
MCPHX31612	3/16 X 1/2"	100
MCPHX31658	3/16 X 5/8"	100
MCPHX31634	3/16 X 3/4"	100

PACK #	SIZE	PACK QTY
MCPHX3161	3/16 X 1"	100
MCPHX316114	3/16 X 1 1/4"	100
MCPHX316112	3/16 X 1 1/2"	100
MCPHX3163	3/16 X 3"	100
MCPHX4134	1/4 X 3/4"	100

MACHINE SCREWS

IMPERIAL - STAINLESS STEEL T304
- CSK SLOT

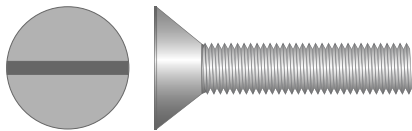

PACK #	SIZE	PACK QTY
MCSX31614	3/16 X 1/4"	100
MCSX31638	3/16 X 3/8"	100
MCSX31612	3/16 X 1/2"	100
MCSX31658	3/16 X 5/8"	100
MCSX31634	3/16 X 3/4"	100
MCSX3161	3/16 X 1"	100
MCSX316114	3/16 X 1 1/4"	100
MCSX316112	3/16 X 1 1/2"	100
MCSX3162	3/16 X 2"	100
MCSX316212	3/16 X 2 1/2"	100
MCSX3163	3/16 X 3"	100
MCSX1412	1/4 X 1/2"	100
MCSX1434	1/4 X 3/4"	100
MCSX141	1/4 X 1"	100
MCSX14114	1/4 X 1 1/4"	100
MCSX142	1/4 X 2"	100
MCSX14212	1/4 X 2 1/2"	100
MCSX143	1/4 X 3"	100
MCSX51634	5/16 X 3/4"	100
MCSX516114	5/16 X 1 1/4"	100
MCSX5162	5/16 X 2"	100
MCSX381	3/8 X 1"	100
MCSX38112	3/8 X 1 1/2"	100
MCSX383	3/8 X 3"	100

IMPERIAL - BRASS
- RND SLOT

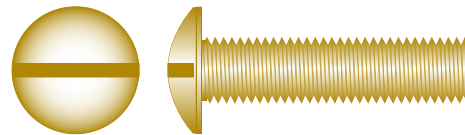

PACK #	SIZE	PACK QTY
MRB1838	1/8 X 3/8"	100
MRB1812	1/8 X 1/2"	100
MRB1858	1/8 X 5/8"	100
MRB1834	1/8 X 3/4"	100
MRB18112	1/8 X 1 1/2"	100
MRB53214	5/32 X 1/4"	100
MRB53258	5/32 X 5/8"	100
MRB5321	5/32 X 1"	100
MRB532112	5/32 X 1 1/2"	100
MRB5322	5/32 X 2"	100
MRB31612	3/16 X 1/2"	100
MRB31634	3/16 X 3/4"	100
MRB3161	3/16 X 1"	100
MRB316112	3/16 X 1 1/2"	100
MRB3162	3/16 X 2"	100
MRB1412	1/4 X 1/2"	100
MRB1458	1/4 X 5/8"	100
MRB1434	1/4 X 3/4"	100
MRB141	1/4 X 1"	100
MRB14114	1/4 X 1 1/4"	100
MRB14112	1/4 X 1 1/2"	100
MRB142	1/4 X 2"	100

**FROM SMALL
FIXES TO BIG
BUILDS, WE'VE
GOT THE
FASTENERS**

Fortress Fasteners Enquiries

0800 42 52 62 | sales@steelandtube.co.nz | steelandtube.co.nz

4

MASONRY ANCHORS



4 MASONRY ANCHORS

THROUGHBOLTS

GALVANISED STAINLESS STEEL T316

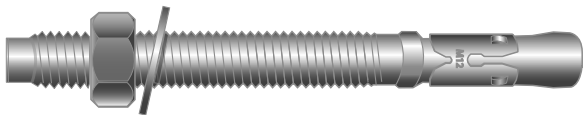

PART #	PART #	SIZE	DRILL Ø	ED(mm)	MT(mm)	PACK QTY
	CFTBX655	6 X 55mm	6	40	8	25
	CFTBX675	6 X 75mm	6	50	12	25
	CFTBX6100	6 X 100mm	6	55	25	25
CFTBG865	CFTBX865	8 X 65mm	8	45	10	25
CFTBG885	CFTBX885	8 X 85mm	8	55	15	25
CFTBG1050	CFTBX1050	10 X 50mm	10	35	8	25
CFTBG1060	CFTBX1060	10 X 60mm	10	42	10	25
CFTBG1075	CFTBX1075	10 X 75mm	10	50	12	25
	CFTBX1090	10 X 90mm	10	60	17	25
CFTBG10100	CFTBX10100	10 X 100mm	10	60	25	25
CFTBG10125	CFTBX10125	10 X 125mm	10	60	30	25
CFTBG1280	CFTBX1280	12 X 80mm	12	60	5	25
CFTBG12100	CFTBX12100	12 X 100mm	12	60	25	25
CFTBG12120	CFTBX12120	12 X 120mm	12	60	40	25
CFTBG12135	CFTBX12135	12 X 135mm	12	80	45	25
CFTBG12180	CFTBX12180	12 X 180mm	12	80	85	10
CFTBG16105	CFTBX16105	16 X 105mm	16	80	5	10
CFTBG16125	CFTBX16125	16 X 125mm	16	100	10	10
CFTBG16140	CFTBX16140	16 X 140mm	16	100	20	10
CFTBG16180	CFTBX16180	16 X 180mm	16	100	60	10
CFTBG20125	CFTBX20120	20 X 120mm	20	100	5	10
CFTBG20160	CFTBX20160	20 X 160mm	20	120	20	10
CFTBG20200		20 X 200mm	20	120	60	10

BOTTOM PLATE ANCHOR PACKS

PART #	SIZE	DRILL Ø	ED(mm)	MT(mm)	PACK QTY
CFTBG12100B25	12 X 100mm	12	60	25	25
CFTBG12120B25	12 X 120mm	12	60	25	25
CFTBG12135B25	12 X 135mm	12	80	45	25
CFTBG12135B50	12 X 135mm	12	80	45	50

SCREWBOLT ANCHOR

GALVANISED

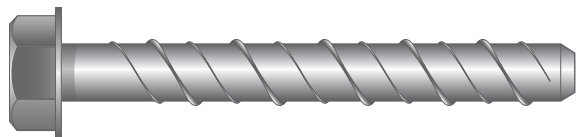

PART #	SIZE	DRILL Ø	MT mm	AF mm	PACK QTY
CFSBH650G	6 X 50mm	6	20	10	25
CFSBH675G	6 X 75mm	6	45		25
CFSBH6100G	6 X 100mm	6	55		25
CFSBH860G	8 X 60mm	8	20	13	25
CFSBH875G	8 X 75mm	8	35		25
CFSBH8100G	8 X 100mm	8	60		25
CFSBH8125G	8 X 125mm	8	60		25
CFSBH1060G	10 X 60mm	10	10	15	25
CFSBH1075G	10 X 75mm	10	25		25
CFSBH10100G	10 X 100mm	10	50		25
CFSBH10140G	10 X 140mm - BLUE HEAD	10	75		25
CFSBH1275G	12 X 75mm	10	15	16	25
CFSBH12100G	12 X 100mm	10	40		25
CFSBH12150G	12 X 150mm	12	90		25
CFSBH12200G	12 X 200mm	12	100		10
CFSBH16100G	16 X 100mm	12	20	21	10
CFSBH16150G	16 X 150mm	12	70		10

4 MASONRY ANCHORS

SEISMIC RATED THROUGHBOLTS

ZINC FLAKE

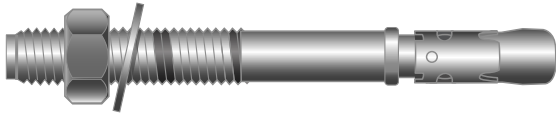

PART #	SIZE	HOLE SIZE	PACK SIZE	SEISMIC RATING
R-HPTIIZF-08065/15	M8 x 65mm	8mm	100	ETA OPT. 1 C1
R-HPTIIZF-08080/15	M8 x 80mm	8mm	100	ETA OPT. 1 C1
R-HPTIIZF-08100/35	M8 x 100mm	8mm	100	ETA OPT. 1 C1
R-HPTIIZF-08115/50	M8 x 115mm	8mm	100	ETA OPT. 1 C1
R-HPTIIZF-10065/5	M10 x 65mm	10mm	50	ETA OPT. 1 C1/C2
R-HPTIIZF-10080/20	M10 x 80mm	10mm	50	ETA OPT. 1 C1/C2
R-HPTIIZF-10095/15	M10 x 95mm	10mm	50	ETA OPT. 1 C1/C2
R-HPTIIZF-10115/35	M10 x 115mm	10mm	50	ETA OPT. 1 C1/C2
R-HPTIIZF-10130/50	M10 x 130mm	10mm	50	ETA OPT. 1 C1/C2
R-HPTIIZF-12080/5	M12 x 80mm	12mm	50	ETA OPT. 1 C1/C2
R-HPTIIZF-12100/5	M12 x 100mm	12mm	50	ETA OPT. 1 C1/C2
R-HPTIIZF-12120/25	M12 x 120mm	12mm	50	ETA OPT. 1 C1/C2
R-HPTIIZF-12135/40	M12 x 135mm	12mm	50	ETA OPT. 1 C1/C2
R-HPTIIZF-12150/55	M12 x 150mm	12mm	50	ETA OPT. 1 C1/C2
R-HPTIIZF-16105/10	M16 x 105mm	16mm	25	ETA OPT. 1 C1/C2
R-HPTIIZF-16125/5	M16 x 125mm	16mm	25	ETA OPT. 1 C1/C2
R-HPTIIZF-16140/20	M16 x 140mm	16mm	25	ETA OPT. 1 C1/C2
R-HPTIIZF-16180/60	M16 x 180mm	16mm	25	ETA OPT. 1 C1/C2
R-HPTIIZF16220/100	M16 x 220mm	16mm	25	ETA OPT. 1 C1/C2
R-HPTIIZF-20125/5	M20 x 125mm	20mm	25	ETA OPT. 1 C1
R-HPTIIZF-20160/20	M20 x 160mm	20mm	25	ETA OPT. 1 C1
R-HPTIIZF-20200/60	M20 x 200mm	20mm	10	ETA OPT. 1 C1



C1 & C2 SEISMIC RATED

SEISMIC RATED THROUGHBOLTS

STAINLESS STEEL T316

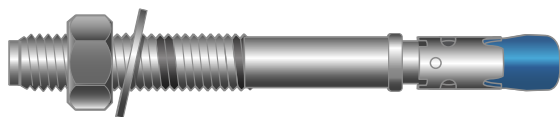

PART #	SIZE	HOLE SIZE	PACK SIZE	SEISMIC RATING
R-HPTIIA4-08060/10	M8 x 60mm	8mm	100	ETA OPT.1 C1
R-HPTIIA4-08075/10	M8 x 75mm	8mm	100	ETA OPT. 1 C1/C2
R-HPTIIA4-08085/20	M8 x 85mm	8mm	100	ETA OPT. 1 C1/C2
R-HPTIIA4-08095/30	M8 x 95mm	8mm	100	ETA OPT. 1 C1/C2
R-HPTIIA4-08105/40	M8 x 105mm	8mm	50	ETA OPT. 1 C1/C2
R-HPTIIA4-08115/50	M8 x 115mm	8mm	100	ETA OPT. 1 C1/C2
R-HPTIIA4-10065/5	M10 x 65mm	10mm	50	ETA OPT. 1 C1/C2
R-HPTIIA4-10080/20	M10 x 80mm	10mm	50	ETA OPT. 1 C1/C2
R-HPTIIA4-10095/15	M10 x 95mm	10mm	50	ETA OPT. 1 C1/C2
R-HPTIIA4-10115/35	M10 x 115mm	10mm	50	ETA OPT. 1 C1/C2
R-HPTIIA4-10130/50	M10 x 130mm	10mm	50	ETA OPT. 1 C1/C2
R-HPTIIA4-10140/60	M10 x 140mm	10mm	50	ETA OPT. 1 C1/C2
R-HPTIIA4-12080/5	M12 x 80mm	12mm	50	ETA OPT. 1 C1/C2
R-HPTIIA4-12100/5	M12 x 100mm	12mm	50	ETA OPT. 1 C1/C2
R-HPTIIA4-12115/20	M12 x 115mm	12mm	50	ETA OPT. 1 C1/C2
R-HPTIIA4-12125/30	M12 x 125mm	12mm	50	ETA OPT. 1 C1/C2
R-HPTIIA4-12150/55	M12 x 150mm	12mm	50	ETA OPT. 1 C1/C2
R-HPTIIA4-12180/85	M12 x 180mm	12mm	50	ETA OPT. 1 C1/C2
R-HPTIIA4-16125/5	M16 x 125mm	16mm	25	ETA OPT. 1 C1
R-HPTIIA4-16140/20	M16 x 140mm	16mm	25	ETA OPT. 1 C1
R-HPTIIA4-16150/30	M16 x 150mm	16mm	25	ETA OPT. 1 C1
R-HPTIIA4-16180/60	M16 x 180mm	16mm	25	ETA OPT. 1 C1



C1 & C2 SEISMIC RATED

4 MASONRY ANCHORS

SEISMIC RATED HEX SCREWBOLTS

ZINC FLAKE

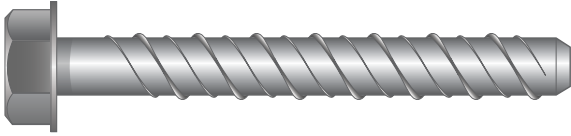

PART #	SIZE	HOLE SIZE	PACK SIZE	SEISMIC RATING
R-LX-06X050-HF-ZF	M6 x 50mm	6mm	100	ETA OPT. 1
R-LX-06X075-HF-ZF	M6 x 75mm	6mm	100	ETA OPT. 1
R-LX-06X100-HF-ZF	M6 x 100mm	6mm	100	ETA OPT. 1
R-LX-06X130-HF-ZF	M6 x 130mm	6mm	100	ETA OPT. 1
R-LX-06X150-HF-ZF	M6 x 150mm	6mm	100	ETA OPT. 1
R-LX-08X060-HF-ZF	M8 x 60mm	8mm	100	ETA OPT. 1 C1/C2
R-LX-08X075-HF-ZF	M8 x 75mm	8mm	100	ETA OPT. 1 C1/C2
R-LX-08X090-HF-ZF	M8 x 90mm	8mm	100	ETA OPT. 1 C1/C2
R-LX-08X100-HF-ZF	M8 x 100mm	8mm	100	ETA OPT. 1 C1/C2
R-LX-08X130-HF-ZF	M8 x 130mm	8mm	50	ETA OPT. 1 C1/C2
R-LX-08X150-HF-ZF	M8 x 150mm	8mm	50	ETA OPT. 1 C1/C2
R-HLX-10X060-HF-ZF	M10 x 60mm	10mm	50	ETA OPT. 1
R-HLX-10X070-HF-ZF	M10 x 70mm	10mm	50	ETA OPT. 1
R-HLX-10X080-HF-ZF	M10 x 80mm	10mm	50	ETA OPT. 1
R-HLX-10X090-HF-ZF	M10 x 90mm	10mm	50	ETA OPT. 1
R-HLX-10X100-HF-ZF	M10 x 100mm	10mm	50	ETA OPT. 1 C1/C2
R-HLX-10X120-HF-ZF	M10 x 120mm	10mm	25	ETA OPT. 1 C1/C2
R-HLX-10X140-HF-ZF	M10 x 140mm	10mm	25	ETA OPT. 1 C1/C2
R-HLX-10X180-HF-ZF	M10 x 180mm	10mm	20	ETA OPT. 1 C1/C2
R-HLX-10X200-HF-ZF	M10 x 200mm	10mm	20	ETA OPT. 1 C1/C2
R-HLX-12X070-HF-ZF	M12 x 70mm	12mm	50	ETA OPT. 1
R-HLX-12X090-HF-ZF	M12 x 90mm	12mm	50	ETA OPT. 1
R-HLX-12X110-HF-ZF	M12 x 110mm	12mm	50	ETA OPT. 1 C1/C2
R-HLX-12X130-HF-ZF	M12 x 130mm	12mm	50	ETA OPT. 1 C1/C2
R-HLX-12X150-HF-ZF	M12 x 150mm	12mm	50	ETA OPT. 1 C1/C2
R-HLX-14X075-HF-ZF	M14 x 75mm	14mm	20	ETA OPT. 1
R-HLX-14X100-HF-ZF	M14 x 100mm	14mm	20	ETA OPT. 1
R-HLX-14X130-HF-ZF	M14 x 130mm	14mm	20	ETA OPT. 1 C1/C2
R-HLX-14X150-HF-ZF	M14 x 150mm	14mm	15	ETA OPT. 1 C1/C2
R-HLX-14X180-HF-ZF	M14 x 180mm	14mm	10	ETA OPT. 1 C1/C2



C1 & C2 SEISMIC RATED

SEISMIC RATED CSK SCREWBOLTS

ZINC FLAKE

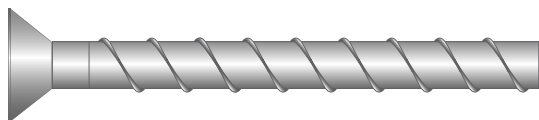

PART #	SIZE	HOLE SIZE	PACK SIZE	SEISMIC RATING
R-LX-06X050-CS-ZF	M6 x 50mm	6mm	100	ETA OPT. 1
R-LX-06X075-CS-ZF	M6 x 75mm	6mm	100	ETA OPT. 1
R-LX-06X100-CS-ZF	M6 x 100mm	6mm	100	ETA OPT. 1
R-LX-06X120-CS-ZF	M6 x 120mm	6mm	100	ETA OPT. 1
R-LX-06X140-CS-ZF	M6 x 140mm	6mm	100	ETA OPT. 1
R-LX-08X060-CS-ZF	M8 x 60mm	8mm	100	ETA OPT. 1 C1/C2
R-LX-08X075-CS-ZF	M8 x 75mm	8mm	100	ETA OPT. 1 C1/C2
R-LX-08X090-CS-ZF	M8 x 90mm	8mm	100	ETA OPT. 1 C1/C2
R-LX-08X100-CS-ZF	M8 x 100mm	8mm	100	ETA OPT. 1 C1/C2
R-LX-08X130-CS-ZF	M8 x 130mm	8mm	50	ETA OPT. 1 C1/C2
R-LX-08X150-CS-ZF	M8 x 150mm	8mm	50	ETA OPT. 1 C1/C2
R-HLX-10X070-CS-ZF	M10 x 70	10mm	50	ETA OPT. 1
R-HLX-10X090-CS-ZF	M10 x 90	10mm	50	ETA OPT. 1
R-HLX-10X100-CS-ZF	M10 x 100	10mm	50	ETA OPT. 1 C1/C2
R-HLX-10X120-CS-ZF	M10 x 120	10mm	25	ETA OPT. 1 C1/C2
R-HLX-10X140-CS-ZF	M10 x 140	10mm	25	ETA OPT. 1 C1/C2

4 MASONRY ANCHORS

RAWLPLUG

R-KEM II WITH THREADED RODS FOR CONCRETE

UNIVERSAL POLYESTER RESIN (STYRENE FREE)



FEATURES AND BENEFITS

- Approved for use in non-cracked concrete (EAD 330499-01-0601), working life up to 100 years
- The most convenient bonded anchor for general purpose use
- Quick, secure and simple installation
- Product with wide spectrum of use in the medium load capacity area
- Ideal for applications where mechanical anchors are not suitable
- Easy dosage thanks to patented self-opening system and use of manual or electric gun
- Option of use standard manual silicone gun
- Winter version not available

APPLICATIONS

- Consoles
- Staircases
- Gates
- High racking
- Canopies
- Sanitary appliances
- Steel constructions
- Railings
- Handrails
- Ladders
- Cable trays

BASE MATERIALS

Approved for use in:

- Non-cracked concrete C20/25-C50/60

Also suitable for use in:

- Natural Stone (after site testing)

APPROVALS AND REPORTS

ETA-21/0243 and UKTA-22/6131
European Approval for 15 substrates



PART #	RESIN	DESCRIPTION / RESIN TYPE	VOLUME (ML)
R-KEM-II-300	R-KEM II	STYRENE FREE POLYESTER RESIN	300

RAWLPLUG

R-KER-II HYBRID RESIN WITH THREADED RODS

UNIVERSAL POLYESTER RESIN (STYRENE FREE)



FEATURES AND BENEFITS

- Approved for use in cracked and non-cracked concrete (EAD 330499-01-0601), working life up to 100 years
- Suitable for use in dry or wet substrates and water filled holes
- For faster curing winter version of the resin can be used
- No need for hole cleaning when using Dustless drill bit
- Special nozzle with longer mixer for more comfortable and precise application
- Suitable for multiple use. Partly used product can be reused after fitting new nozzle
- Very high load capacity
- Tests in fire conditions confirm the fire resistance up to R120

APPLICATIONS

- Curtain walling
- Balustrading
- Handrails
- Canopies
- Cable conduits and trays
- Fencing & gates manufacturing and installation
- Pipework/ductwork supports
- Platforms
- Pipelines systems
- Passenger lifts
- Safety barriers
- Formwork support systems
- Structural steelwork
- Street lamps
- Racking systems
- Barriers

BASE MATERIALS

Approved for use in:

- Cracked concrete C20/25-C50/60
- Non-cracked concrete C20/25-C50/60

APPROVALS AND REPORTS

ETA-21/0242 and UKTA-22/6130



PART #	RESIN	DESCRIPTION / RESIN TYPE	VOLUME (ML)
R-KER-II-300	R-KER II	R-KER II HYBRID RESIN	300
R-KER-II-400			400

4 MASONRY ANCHORS

RAWLPLUG

R-KEX II WITH REBARS AS AN ANCHOR

PREMIUM PURE EPOXY RESIN APPROVED FOR USE WITH REINFORCEMENT BARS



FEATURES AND BENEFITS

- The strongest resin in the epoxy resin class
- Approved for use in cracked and non-cracked concrete (EAD 330499-01-0601), working life up to 100 years
- Suitable for use in dry and wet substrates including flooded holes (use category II & I2)
- Diamond and hammer drilling
- Seismic category C1, C2
- Very high chemical resistance – suitable for applications exposed to influence of various agents (industrial or marine environment)
- Minimal shrinkage provides option of use in diamond-drilled holes and oversized holes
- Extended working time ensures easy installation of metal components (up to 30 min. in 20°C)
- For use in positive temperatures

APPLICATIONS

- Safety barriers
- Temporary works/ formworks support systems
- Rebar
- Curtain walling
- Formwork support systems
- Masonry support
- Platforms
- Structural steelwork
- Rebar dowelling
- Starter bars
- Rebar missed-outs

BASE MATERIALS

Approved for use in:

- Non-cracked concrete C20/25-C50/60
- Cracked concrete C20/25-C50/60

Also suitable for use in:

- High-Density Natural Stone

APPROVALS AND REPORTS

ETA-21/0244 and UKTA-22/6132



PART #	RESIN	DESCRIPTION / RESIN TYPE	VOLUME (ML)
R-KEX-II-385	R-KEX II	EPOXY RESIN	385
R-KEX-II-600			600

RAWLPLUG

INSTALLATION GUIDE



1. Drill hole to the required diameter and depth for stud size being used.
2. Solid substrates: clean the drill hole thoroughly with brush and hand pump at least four times before installation.
3. Insert cartridge into gun and attach nozzle.
4. Dispense to waste until even colour is obtained.
5. Insert the mixer nozzle to the bottom of the drill hole and inject resin, slowly withdrawing the nozzle as the hole is filled to 70% of its depth.
6. Immediately insert the stud, slowly and with slight twisting motion. Remove any excess resin around the hole before it sets and leave it undisturbed until the curing time elapses.
7. Attach fixture and tighten the nut to the required torque.

4 MASONRY ANCHORS

TX CON MASONRY SCREWS

HEX HEAD - MECH GALV

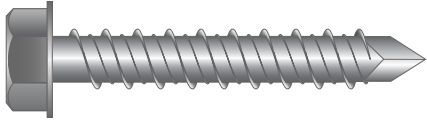

PART #	DIAMETER/LENGTH	HOLE SIZE (mm)	PACK QTY
CFCSH6532MG	6.5 x 32mm	5mm	100
CFCSH6545MG	6.5 x 45mm		100
CFCSH6557MG	6.5 x 57mm		100
CFCSH6570MG	6.5 x 70mm		100
CFCSH6583MG	6.5 x 83mm		100
CFCSH65102MG	6.5 x 102mm		100

TX CON MASONRY SCREWS

CSK HEAD - MECH GALV

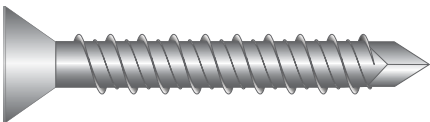

PART #	DIAMETER/LENGTH	HOLE SIZE (mm)	PACK QTY
CFCSC532MG	5 x 32mm	4mm	100
CFCSC545MG	5 x 45mm		100
CFCSC558MG	5 x 58mm		100
CFCSC570MG	5 x 70mm		100
CFCSC6545MG	6.5 x 45mm	5mm	100
CFCSC6557MG	6.5 x 57mm		100
CFCSC6570MG	6.5 x 70mm		100
CFCSC6583MG	6.5 x 83mm		100
CFCSC65102MG	6.5 x 102mm		100

CHEMICAL STUD ANCHOR

GALVANISED STAINLESS STEEL T316

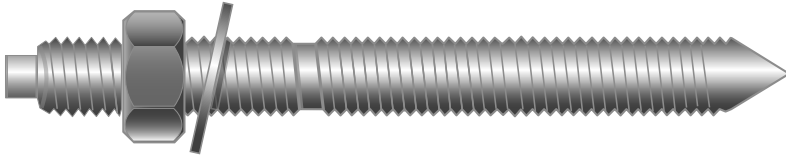

PART #	PART #	SIZE	DRILL Ø	MT(mm)	PACK QTY
CFCSG10160	CFCSX10160	10 X 130mm	12	28	10
CFCSG12160	CFCSX12160	12 X 160mm	14	36	10
CFCSG16190	CFCSX16190	16 X 190mm	18	42	10
CFCSG20260	CFCSX20260	20 X 260mm	22	72	10
CFCSG24300	CFCSX24300	24 X 300mm	26	66	10

4 MASONRY ANCHORS

SLEEVE ANCHOR

GALVANISED STAINLESS STEEL T316 ZINC CHROMATE

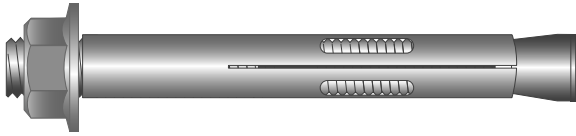

PART #	PART #	PART #	SIZE	DRILL Ø	ED(mm)	MT(mm)	PACK QTY
		CFSAZ6520	6.5 X 20mm	6.5	15	5	25
		CFSAZ6525	6.5 X 25mm	6.5	20	5	25
	CFSAX6535	CFSAZ6536	6.5 X 35mm	6.5	30	5	25
	CFSAX6555	CFSAZ6555	6.5 X 55mm	6.5	30	25	25
	CFSAX6575	CFSAZ6575	6.5 X 75mm	6.5	30	45	25
CFSAG840	CFSAX840	CFSAZ840	8 X 40mm	8	35	5	25
CFSAG865	CFSAX865	CFSAZ865	8 X 65mm	8	35	30	25
		CFSAZ885	8 X 85mm	8	35	50	25
		CFSAZ1040	10 X 40mm	10	34	6	25
CFSAG1050	CFSAX1050	CFSAZ1050	10 X 50mm	10	40	10	25
CFSAG1060		CFSAZ1060	10 X 60mm	10	40	20	25
CFSAG1075	CFSAX1075	CFSAZ1075	10 X 75mm	10	40	35	25
CFSAG1095	CFSAX1095	CFSAZ1095	10 X 95mm	10	40	55	25
		CFSAZ10125	10 X 125mm	10	40	85	25
CFSAG1260	CFSAX1260	CFSAZ1260	12 X 60mm	12	50	10	25
CFSAG1275	CFSAX1275	CFSAZ1275	12 X 75mm	12	50	25	25
CFSAG12100	CFSAX12100	CFSAZ12100	12 X 100mm	12	50	50	25
CFSAG12130		CFSAZ12130	12 X 130mm	12	50	80	25
CFSAG1665		CFSAZ1665	16 X 65mm	16	55	10	25
		CFSAZ16110	16 X 110mm	16	55	55	25
		CFSAZ16145	16 X 145mm	16	55	90	25
CFSAG2075		CFSAZ2075	20 X 75mm	20	60	15	25
		CFSAZ20105	20 X 105mm	20	60	45	25
		CFSAZ20150	20 X 150mm	20	60	90	25

HOOK/EYE SLEEVE ANCHOR

ZINC CHROMATE

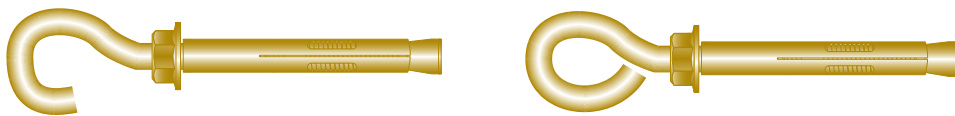

PART #	SIZE	DRILL Ø	ED mm	PACK QTY
CFSAHB845	8 X 45mm	8	45	25
CFSAEB845	8 X 45mm	8	45	25

CSK SLEEVE ANCHOR

ZINC CHROMATE



PART #	SIZE	DRILL Ø	MT mm	ED mm	PACK QTY
CFSAC6536	6.5 X 36mm	6.5	5	30	25
CFSAC6555	6.5 X 55mm	6.5	25	30	25
CFSAC6575	6.5 X 75mm	6.5	45	30	25
CFSAC65100	6.5 X 100mm	8	70	30	25
CFSAC860	8 X 60mm	8	25	35	25
CFSAC885	8 X 85mm	8	50	35	25
CFSAC8100	8 X 100mm	8	60	40	25
CFSAC1075	10 X 75mm	10	35	40	25
CFSAC10100	10 X 100mm	12	60	40Z	25
CFSAC10120	10 X 120mm	12	80	40	25

4 MASONRY ANCHORS

MASONRY NAILS

CARBON STEEL ZINC PLATED

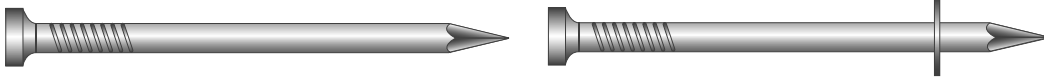

PART #	PART # - WITH WASHER	SIZE	PACK QTY
CFMNA325	CFMNA325	3 X 25mm	200
CFMNA330	CFMNA330	3 X 30mm	200
CFMNA340	CFMNA340	3 X 40mm	200
CFMNA350		3 X 50mm	200
CFMNA425		4 X 25mm	200
CFMNA430		4 X 30mm	200
CFMNA440		4 X 40mm	200
CFMNA450		4 X 50mm	200
CFMNA465		4 X 65mm	200
CFMNA475		4 X 75mm	100
CFMNA4100		4 X 100mm	100

HI-T MUSHROOM ANCHOR

MECH GALVANISED



PART #	SIZE	MIN. EMBEDMENT DEPTH	MAX. FIXTURE THICKNESS	DRILL DIAMETER	HEAD DIAMETER	HEAD HEIGHT	MIN. SPACING	MIN EDGE DISTANCE	PACK QTY
		(mm)	(mm)	(mm)	(mm)	(mm)	(mm)	(mm)	
CFSPM525G	5mm X 25mm	20	3	5	11	3	50	60	100
CFSPM532G	5mm X 32mm	20	6	5	11	3	50	60	100
CFSPM538G	5mm X 38mm	20	10	5	11	3	50	60	100
CFSPM550G	5mm X 50mm	20	18	5	11	3	50	60	100
CFSPM6525G	6.5mm X 25mm	25	2	6.5	12	3.2	65	78	100
CFSPM6538G	6.5mm X 38mm	25	6	6.5	12	3.2	65	78	100
CFSPM6550G	6.5mm X 50mm	25	18	6.5	12	3.2	65	78	100
CFSPM6563G	6.5mm X 63mm	25	30	6.5	12	3.2	65	78	100
CFSPM6575G	6.5mm X 75mm	30	42	6.5	12	3.2	65	78	100
CFSPM65100G	6.5mm X 100mm	30	65	6.5	12	3.2	65	78	100

4 MASONRY ANCHORS

HI-T COUNTERSUNK ANCHOR

MECH GALVANISED



PART #	SIZE	MIN. EMBEDMENT DEPTH	MAX. FIXTURE THICKNESS	DRILL DIAMETER	HEAD DIAMETER	HEAD HEIGHT	MIN. SPACING	MIN EDGE DISTANCE	PACK QTY
		(mm)	(mm)	(mm)	(mm)	(mm)	(mm)	(mm)	
CPSPC565MG	5mm X 65mm	20	32	5	11	3.5	50	60	100
CPSPC575MG	5mm X 75mm	25	41	5	11	3.5	50	60	100
CPSPC5100MG	5mm X 100mm	30	65	5	11	3.5	50	60	100
CFSPC6538MG	6.5mm X 38mm	25	6	6.5	12	4	65	78	100
CFSPC6550MG	6.5mm X 50mm	25	16	6.5	12	4	65	78	100
CFSPC6565MG	6.5mm X 65mm	25	32	6.5	12	4	65	78	100
CFSPC6575MG	6.5mm X 75mm	30	41	6.5	12	4	65	78	100
CFSPC65100MG	6.5mm X 100mm	30	65	6.5	12	4	65	78	100

MUSH SPLIT DRIVE ANCHOR

CARBON STEEL ZINC PLATED

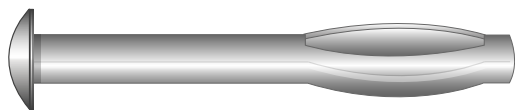

PART #	SIZE	DRILL Ø	MT(mm)	PACK QTY
CFSPM525	5 X 25mm	5	3	100
CFSPM532	5 X 32mm	5	10	100
CFSPM538	5 X 38mm	5	6	100
CFSPM550	5 X 50mm	5	19	100
CFSPM575	5 X 75mm	5	44	100
CFSPM6532	6.5 X 32mm	6.5	19	100
CFSPM6538	6.5 X 38mm	6.5	6	100
CFSPM6550	6.5 X 50mm	6.5	19	100
CFSPM6563	6.5 X 63mm	6.5	32	100
CFSPM6575	6.5 X 75mm	6.5	44	100
CFSPM65100	6.5 X 100mm	6.5	68	100

CSK SPLIT DRIVE ANCHOR

CARBON STEEL ZINC PLATED



PART #	SIZE	DRILL Ø	MT	PACK QTY
CFSPF560	5 X 60mm	5	28	100
CFSPF565	5 X 65mm	5	33	100
CFSPF575	5 X 75mm	5	43	100
CFSPF5100	5 X 100mm	5	68	100
CFSPF6538	6.5 X 38mm	6.5	6	100
CFSPF6550	6.5 X 50mm	6.5	18	100
CFSPF6564	6.5 X 64mm	6.5	33	100
CFSPF6575	6.5 X 75mm	6.5	43	100
CFSPF65100	6.5 X 100mm	6.5	68	100

4 MASONRY ANCHORS

PLASTER BOARD SCREWS

CARBON STEEL ZINC PLATED / NYLON

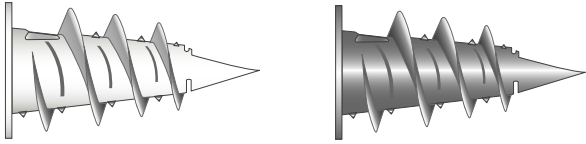

PART #	SIZE	SCREW mm	PACK QTY
NYLON - CFAIPN	METAL - CFZIPM	6G-8G	100

NYLON WALL PLUGS

NYLON

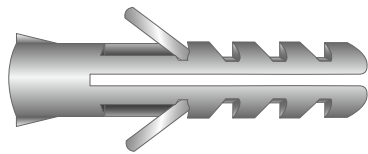

PART #	SIZE	DRILL Ø	ED mm	SCREW mm	PACK QTY
CFNYP525	5 X 25mm	5	25	3.0-3.5	100
CFNYP630	6 X 30mm	6	30	3.5-4.5	100
CFNYP738	7 X 38mm	7	38	4.5-5.5	100
CFNYP840	8 X 40mm	8	40	5.0-6.0	100
CFNYP1050	10 X 50mm	10	50	6.0-7.5	100

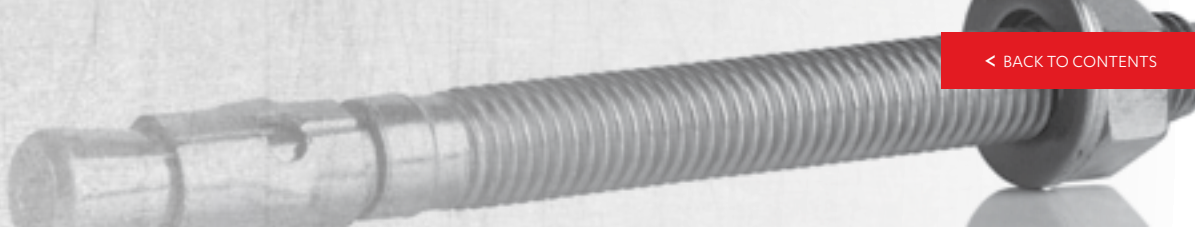

MUSH NAIL IN ANCHOR

CARBON STEEL ZINC PLATED PIN [STAINLESS STEEL T304 PIN](#)

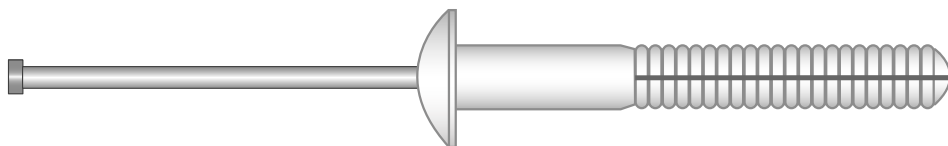

PART #	PART #	SIZE	DRILL Ø	MT(mm)	PACK QTY
CFNIAM525		5 X 25mm	5	6.5	100
CFNIAM6525	CFNIAMX6525	6.5 X 25mm	6.5	6.5	100
CFNIAM6538		6.5 X 38mm	6.5	19	100
CFNIAM6550		6.5 X 50mm	6.5	21	100
CFNIAM6575		6.5 X 75mm	6.5	50	100

CSK NAIL IN ANCHOR

CARBON STEEL ZINC PLATED PIN

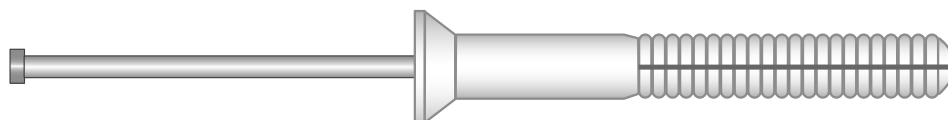

PART #	SIZE	DRILL Ø	MT(mm)	PACK QTY
CFNIAC525	5 X 25mm	5	6.5	100
CFNIAC6525	6.5 X 25mm	6.5	6.5	100
CFNIAC6538	6.5 X 38mm	6.5	19	100
CFNIAC6550	6.5 X 50mm	6.5	21	100
CFNIAC6575	6.5 X 75mm	6.5	50	100

4 MASONRY ANCHORS

ROUND NAIL IN ANCHOR

CARBON STEEL ZINC PLATED PIN STAINLESS STEEL T304 PIN

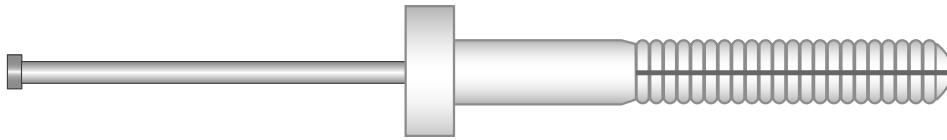

PART #	PART #	SIZE	DRILL Ø	MT(mm)	PACK QTY
CFNIAR525	CFNIARX525	5 X 25mm	5	6.5	100
CFNIAR6525	CFNIARX6525	6.5 X 25mm	6.5	6.5	100
CFNIAR6538	CFNIARX6538	6.5 X 38mm	6.5	19	100
CFNIAR6550		6.5 X 50mm	6.5	21	100
CFNIAR6575		6.5 X 75mm	6.5	50	100

METAL PIN ANCHOR

CARBON STEEL ZINC PLATED PIN



PART #	SIZE	DRILL Ø	MT(mm)	PACK QTY
CFMPA522	5 X 25mm	5	6.5	100
CFMPA6525	6.5 X 25mm	6.5	6.5	100
CFMPA6532	6.5 X 32mm	6.5	17	100
CFMPA6538	6.5 X 38mm	6.5	23	100
CFMPA6550	6.5 X 50mm	6.5	32	100

MULTI SCREWS

CLASS 3



PART #	SIZE	DRILL Ø	SQ #	PACK QTY
CFMS6532	6.5 X 32mm	5	#2	100
CFMS6550	6.5 X 50mm	5	#2	100

MULTI SCREW HEX FLANGE HEAD

CLASS 3



PART #	SIZE	DRILL Ø	HEX	PACK QTY
CFMS6532H	6.5 X 32mm	5	5/16"	100
CFMS6550H	6.5 X 50mm	5	5/16"	100

4 MASONRY ANCHORS

HOLLOW WALL ANCHORS

ZINC

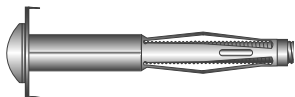

PART #	SIZE	DRILL Ø	MT (mm)	PACK QTY
CFHWA14S	FOR 10-12mm WALL THICKNESS	11	10-12	50
CFHWA18L	FOR 16-24mm WALL THICKNESS	8	16-24	100
CFHWA18SL	FOR 13-16mm WALL THICKNESS	8	13-16	100
CFHWA18XS	FOR 4-5mm WALL THICKNESS	8	4-5	100

Fortress Fasteners Enquiries

0800 42 52 62 | sales@steelandtube.co.nz | steelandtube.co.nz

5 BUILDING HARDWARE



5 BUILDING HARDWARE

JOIST HANGERS

GALVANISED STAINLESS STEEL



PART #	PRODUCT DESCRIPTION	PACK SIZE	THICKNESS / MATERIAL
BHJHX4780	47 X 80 JOIST HANGER S/S T304	25	1.0mm 304
BHJHX47120	47 X 120 JOIST HANGER S/S T304	25	1.0mm 304
BHJHX47180	47 X 180 JOIST HANGER S/S T304	20	1.0mm 304
BHJHX95165	95 X 165 JOIST HANGER S/S T304	20	1.0mm 304
BHJH4780G	47 X 80 JOIST HANGER GALV	25	1.0mm G300 Z275
BHJH47120G	47 X 120 JOIST HANGER GALV	25	1.0mm G300 Z275
BHJH47180G	47 X 180 JOIST HANGER GALV	20	1.0mm G300 Z275
BHJH52120G	52 X 120 JOIST HANGER GALV	25	1.0mm G300 Z275
BHJH52180G	52 X 180 JOIST HANGER GALV	20	1.0mm G300 Z275
BHJH95165G	95 X 165 JOIST HANGERS GALV	20	1.0mm G300 Z275

CYCLONE TIES

GALVANISED



PART #	PRODUCT DESCRIPTION	PACK SIZE	MATERIAL
BHCT400G	400mm CYCLONE TIE GALV	EA	G300 Z275
BHCT600G	600mm CYCLONE TIE GALV	EA	G300 Z275

CEILING HANGERS

GALVANISED STAINLESS STEEL



PART #	PRODUCT DESCRIPTION	PACK SIZE	THICKNESS / MATERIAL
BHCLXL	CT160 LEFT CLEAT S/S T304 FOR PILE FIXING	20	1.0mm T304
BHCLXR	CT160 RIGHT CLEAT S/S T304 FOR PILE FIXING	20	1.0mm T304
BHCLXL200	CT200 LEFT CLEAT S/S T304 FOR PILE FIXING	EA	1.0mm T304
BHCLXR200	CT200 RIGHT CLEAT S/S T304 FOR PILE FIXING	EA	1.0mm T304
BHCHLG	200mm LEFT CEILING HANGER GALV	EA	1.0mm G300 Z275
BHCHRG	200mm RIGHT CEILING HANGER GALV	EA	1.0mm G300 Z275

CONCEALED PURLIN CLEATS

GALVANISED STAINLESS STEEL



PART #	PRODUCT DESCRIPTION	PACK SIZE	THICKNESS / MATERIAL
BHXCPC40S	47 X 40 CONCEALED PURLIN CLEAT (CPC) S/S T304	25	1.6mm T304
BHXCPC40	86 X 40 CONCEALED PURLIN CLEAT (CPC) S/S T304	25	1.6mm T304
BHXCPC80	86 X 80 CONCEALED PURLIN CLEAT (CPC) S/S T304	25	1.6mm T304
BHCPC40S	47 X 40 CONCEALED PURLIN CLEAT (CPC) GALV	25	1.60mm G300 Z275
BHCPC40	86 X 40 CONCEALED PURLIN CLEAT (CPC) GALV	25	1.60mm G300 Z275
BHCPC80	86 X 80 CONCEALED PURLIN CLEAT (CPC) GALV	25	1.60mm G300 Z275

5 BUILDING HARDWARE

TIMBA TIES

GALVANISED STAINLESS STEEL



PART #	PRODUCT DESCRIPTION	PACK SIZE	THICKNESS / MATERIAL
BHTTX	TIMBA TIE WOOD CONNECTOR WITH SCREWS	50	5.0mm T304
BHTTG	TIMBA TIE WOOD CONNECTOR WITH SCREWS GALV	50	5.0mm

Z NAILS

GALVANISED STAINLESS STEEL



PART #	PRODUCT DESCRIPTION	PACK SIZE	THICKNESS / MATERIAL
BHWDXL	LEFT HAND Z NAILS S/S T304	100	5.0mm T304
BHWDXR	RIGHT HAND Z NAILS S/S T304	100	5.0mm T304
BHWDXS	STRAIGHT Z NAILS S/S T304	100	5.0mm T304
BHWDGL	LEFT HAND Z NAILS GALV (25)	100	5.0mm
BHWDGR	RIGHT HAND Z NAILS GALV (25)	100	5.0mm
BHWDGS	STRAIGHT Z NAILS GALV (25)	100	5.0mm

MULTI GRIPS

GALVANISED STAINLESS STEEL



PART #	PRODUCT DESCRIPTION	PACK SIZE	THICKNESS / MATERIAL
BHMGX93	93mm MULTI GRIP S/S T304	100	1.0mm T304
BHMGX125	125mm MULTI GRIP S/S T304	100	1.0mm T304
BHMG93G	93mm MULTIGRIP GALV	100	1.0mm G300 Z275
BHMG125G	125mm MULTIGRIP GALV	100	1.0mm G300 Z275

12KN & 6KN PILE FIXING

STAINLESS STEEL



PART #	PRODUCT DESCRIPTION	PACK SIZE
BHX12KN	12KN PILE FIXING PACK S/S T304	1
BHX12KNRETRO	12KN RETRO PILE FIXING PACK S/S T304 (KIT FOR 4 PILES)	1
BHX6KN	6KN PILE FIXING PACK S/S T304	1

BRACING BRACKETS

GALVANISED



PART #	PRODUCT DESCRIPTION	PACK SIZE	MATERIAL
BHBB	95mm BRACING BRACKET + T17 SCREWS CLASS 4	1 PAIR	GALV
BHBBSB10	BRACING BRACKET + 10 X 140 GALV SCREWBOLTS + T17 SCREWS CLASS 4	1 PAIR	GALV
BHBBSB10B	BRACING BRACKET + 10 X 140 GALV SCREWBOLTS + T17 SCREWS CLASS 4 - BUCKET	5 PAIRS	GALV
CFSBH10140G	10 X 140 SCREW BOLT GALV HEX BLUE HEAD	25	GALV

5 BUILDING HARDWARE

STRAPPING

GALVANISED STAINLESS STEEL



PART #	PRODUCT DESCRIPTION	PACK SIZE	THICKNESS / MATERIAL
BHSBSX300	300 X 25 SHEET BRACING STRAP S/S T304	10	1.0mm 304
BHSBSX400	400 X 25 SHEET BRACING STRAP S/S T304	10	1.0mm 304
BHSBSX600	600 X 25 SHEET BRACING STRAP S/S T304	10	1.0mm 304
BHSB300G	300 X 25 SHEET BRACING STRAP GALV	10	1.0mm G300 Z275
BHSB400G	400 X 25 SHEET BRACING STRAP GALV	10	1.0mm G300 Z275
BHSB600G	600 X 25 SHEET BRACING STRAP GALV	10	1.0mm G300 Z275
BHBS2510	25mm X 10M BRACE STRAPPING COIL	1	0.80mm G550 AZ150
BHBS2530	25mm X 30M BRACE STRAPPING COIL + 5 TENSIONERS GALV	1	0.80mm G550 AZ150
BHBS5030	50mm X 30M BRACE STRAPPING COIL	1	0.80mm G550 AZ150
BHBST50	50mm BRACE STRAPPING TENSIONER (PACK OF 5)	5	

GIRT CONNECTOR

GALVANISED



PART #	PRODUCT DESCRIPTION	PACK SIZE	THICKNESS / MATERIAL
BHGP	120mm 90DEG GIRT CONNECTOR	EA	1.0mm G300 Z275

OTHER BRACKETS

GALVANISED STAINLESS STEEL



PART #	PRODUCT DESCRIPTION	PACK SIZE	THICKNESS / MATERIAL
BHGRIPPER	HAMMER ON SNAP OFF CONNECTORS (STRIP OF 5) GALV	500	G300 Z275
BHSS195G	195mm STUD STRAP GALV	EACH	1.0mm G300 Z275
BHNPX40101	40 X 101 NAIL PLATE S/S T304	10	T304
BHNPX67127	67 X 127 NAIL PLATE S/S T304	10	T304

NAILS AND SCREWS FOR HARDWARE

GALVANISED STAINLESS STEEL

PART #	PRODUCT DESCRIPTION	PACK SIZE	MATERIAL / COATING
BHNX3330	3.3mm X 30mm FLAT HD NAILS A/G	500G	T304
BHNX3345	3.3mm X 45mm FLAT HD NAILS A/G	500G	T304
BHN31530G	3.15mm X 30mm FLAT HD NAILS GALV 500G	500G	GALV
TTX1235T	12G X 35 HEX W/F T17 NO NEO S/S	200	T316
TTX1435T	14-10 X 35 HEX W/F T17 NO NEO S/S	200	T316
TTX1475T	14-10 X 75 HEX W/F T17 NO NEO S/S	100	T316
TT1235C4	12G X 35 HEX W/F T17 NO NEO CL:4	200	CLASS 4
TT1435C4	14G X 35 HEX W/F T17 NO NEO CL:4	200	CLASS 4
TT1475C4	14G X 75 HEX W/F T17 NO NEO CL:4	100	CLASS 4
SKAPWTM6120C4	TOP PLATE SCREW M6 X 120mm TORX MECH GALV	100	M GALV
SKAPWTM6160C4	TOP PLATE SCREW M6 X 160mm TORX MECH GALV	100	M GALV
PUR1080BP100	10G X 80 CSK SQDR T17 BLUE PURLIN SCREW	100	RUSPERT
PUR1080BP500	10G X 80 CSK SQDR T17 BLUE PURLIN SCREW	500	RUSPERT

SOLID FASTENERS FOR SECURE CONNECTIONS

Fortress Fasteners Enquiries

0800 42 52 62 | sales@steelandtube.co.nz | steelandtube.co.nz

6

COLLATED NAILS

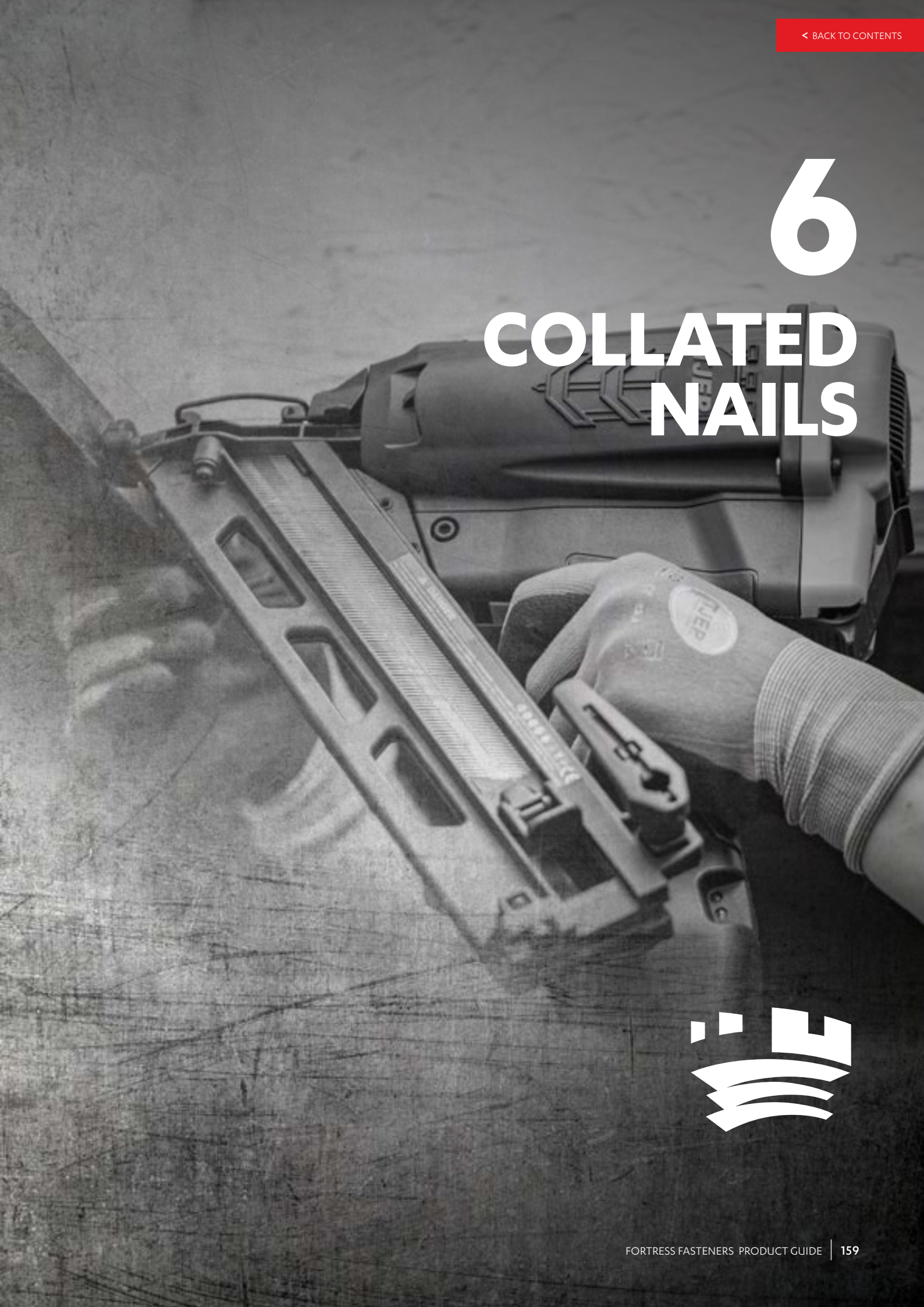



THE NEW GENERATION OF TJEP GAS-TOOLS

- > Improved design and ergonomics
- > Quick and effective tools
- > New Li-ion battery with fast charging

TJEP gas-powered nailers (Cordless Nailers) are based on gas technology and particularly for the professional user who wants great power and maximum freedom of movement.



FIND OUT MORE,
WATCH THE VIDEO



TJEP fuel cell, yellow, 78 mm



TJEP fuel cell, red, 165 mm.
Full function down to -15°C



TJEP fuel cell, purple, 165 mm.
Full function down to -15°C
Extra power for 100mm framer

TJEP GRF 34/100 EXCELLENT GAS

CORDLESS GAS FRAMING NAILER



SPECIFICATIONS

PART #:	FNZ-100200
EAN NO.	5702557002001
TYPE	GAS NAILER
SIZE (L W H)	347 X 120 X 401
WEIGHT	4.1 KG
SHOT PER FUEL CELL	CA. 1000
SHOT BEFORE RECHARGING	CA. 8000

FASTENERS

LENGTH	63 - 100 mm
DIAMETER	2.8 - 3.3 mm
ANGLE	34 DEGREES

TJEP GRF 34/100 Excellent GAS is the latest addition within nailers that do not use a compressor and hose. With its low weight and extreme power, TJEP GRF 34/100 Excellent GAS is one of the most versatile gas nailers on the market and it can shoot up to 100 mm ring nail - even in hard construction wood.

KEY PRODUCT FEATURES

- + Great balance
- + Li-ion battery - approx. 8000 shots per charge
- + Battery indicator
- + Extreme power - one of the strongest in the market
- + Adjustable depth control
- + Belt hook
- + No-mark nose

CONSUMABLES

PART #	PRODUCT DESCRIPTION	PACK SIZE	FINISH
FNZ-FT75BR	3.05 X 75 mm COLLATED NAIL	3000	BRIGHT
FNZ-FT90BR/1	3.15 X 90 mm COLLATED NAIL	3000	BRIGHT
FNZ-H90315BR	3.15 X 90 mm D HEAD COLLATED NAIL	1000	BRIGHT
FNZ-GE25ASBF	2.80 X 65 mm AG FLOORING NAIL	2000	GALV
FNZ-FT75GAL	3.05 X 75 mm D HEAD COLLATED	3000	GALV
FNZ-FT90GAL	3.15 X 90 mm COLLATED NAIL	3000	GALV
FNZ-833028	3.40 X 100 mm COLLATED NAIL ROUND HD RING SHANK	1500	GALV
FNZ-H90315GAL	3.15 X 90 mm D HEAD, COLLATED NAIL	1000	GALV
FNZ-FT75SS	3.05 X 75 mm D HEAD COLLATED NAIL RING SHANK	1000	STAINLESS STEEL
FNZ-FT90SS	3.15 X 90 mm COLLATED NAIL RING SHANK	1000	STAINLESS STEEL
FNZ-FTR90SS	3.15 X 90 mm ROUND HD COLLATED NAIL	1000	STAINLESS STEEL
FNZ - 833398	3.15 X 100 mm ROUND HEAD COLLATED NAIL T316 RING SHANK	810	STAINLESS STEEL

6 COLLATED NAILS AND TOOLS

TJEP GRF 34/90 GAS 3G

CORDLESS GAS FRAMING NAILER



SPECIFICATIONS

PART #:	FNZ-100205
EAN NO.	5702551002056
TYPE	GAS NAILER
SIZE (L W H)	381 X 108 X 377 mm
WEIGHT	3.68 KG
SHOT PER FUEL CELL	CA. 1100
SHOT BEFORE RECHARGING	CA. 8000

FASTENERS

LENGTH	50 - 90 mm 50 - 80 mm RING NAILS
DIAMETER	2.8 - 3.1 mm
ANGLE	34 DEGREES

Gas nailer with high power for raftering, plywood, laths, siding, flooring, boarding, decking etc.

KEY PRODUCT FEATURES



- + Great balance
- + Adjustable depth control
- + Rubber pad – anti-skid
- + Easy to clean
- + Rafter/belt hook
- + Rear two-step loading
- + No-mark nose (Flooring and Decra nose also available)

CONSUMABLES

PART #	PRODUCT DESCRIPTION	PACK SIZE	FINISH
FNZ-FT50BRR	2.87 X 50mm COLLATED NAIL RING SHANK	3000	BRIGHT
FNZ-FT75BR	3.05 X 75 mm COLLATED NAIL	3000	BRIGHT
FNZ-FT90BR/1	3.15 X 90 mm COLLATED NAIL	3000	BRIGHT
FNZ-H90315BR	3.15 X 90 mm D HEAD COLLATED NAIL	1000	BRIGHT
FNZ-FT50GAL	2.87 X 50 mm COLLATED NAIL	3000	GALV
FNZ-FTR50GAL	2.87 X 50 mm RND HD COLLATED NAIL	1000	GALV
FNZ-GE25ASBFT	2.87mm X 65mm RING SHANK D HEAD HD GALV GUN NAIL	2500	GALV
FNZ-FTR65GAL	2.87 X 65 mm RND HD COLLATED NAIL	1000	GALV
FNZ-FT75GAL	3.05 X 75 mm D HEAD COLLATED	3000	GALV
FNZ-FT90GAL	3.15 X 90 mm COLLATED NAIL	3000	GALV
FNZ-H90315GAL	3.15 X 90 mm D HEAD COLLATED NAIL	1000	GALV
FNZ-FTR50SS	2.87 X 50 mm RND HD COLLATED NAIL	1000	STAINLESS STEEL
FNZ-FTR75SS	3.05 X 75 mm RND HD COLLATED NAIL	1000	STAINLESS STEEL
FNZ-FT75SS	3.05 X 75 mm D HEAD COLLATED NAIL RING SHANK	1000	STAINLESS STEEL
FNZ-FTR90SS	3.15 X 90 mm RND HD COLLATED NAIL	1000	STAINLESS STEEL
FNZ-FT90SS	3.15 X 90 mm COLLATED NAIL RING SHANK	1000	STAINLESS STEEL

TJEP VF-16/64 GAS 3G FINISH NAILER CORDLESS 16G ANGLE BRADDER

SPECIFICATIONS

PART #	FNZ-100230
EAN NO.	5702551002308
TYPE	GAS NAILER
SIZE (L W H)	350 X 96 X 270 mm
WEIGHT	2.20 KG
SHOT PER FUEL CELL	CA. 1100
SHOT BEFORE RECHARGING	CA. 8000

FASTENERS

LENGTH	32 - 64 mm
DIAMETER	1.6 mm
ANGLE	20 DEGREES



KEY PRODUCT FEATURES

- + Li-ion battery - approx. 8000 shots per charge
- + Battery indicator
- + Quick removal of 'trapped' brad
- + Adjustable depth control
- + Rear two-step loading
- + Belt hook
- + No-mark nose

For all second fix and joinery tasks, including coving and skirting etc.

CONSUMABLES

PART #	PRODUCT DESCRIPTION	PACK SIZE	FINISH
FNZ-842432	16G ANGLE BRAD 32 mm	2000	GALV
FNZ-842438	16G ANGLE BRAD 38 mm	2000	GALV
FNZ-842445	16G ANGLE BRAD 45 mm	2000	GALV
FNZ-842451	16G ANGLE BRAD 51 mm	2000	GALV
FNZ-842463	16G ANGLE BRAD 63 mm	2000	GALV
FNZ-842433	16G ANGLE BRAD 32 mm	2000	STAINLESS STEEL
FNZ-842439	16G ANGLE BRAD 38 mm	2000	STAINLESS STEEL
FNZ-842452	16G ANGLE BRAD 51 mm	2000	STAINLESS STEEL

6 COLLATED NAILS AND TOOLS

TJEP AB-15/64 GAS 3G FINISH NAILER CORDLESS 15G ANGLE DA TYPE ANGLE BRADDER



SPECIFICATIONS

PART #	FNZ-100235
EAN NO.	5702551002353
TYPE	GAS BRADDER
SIZE (L W H)	350 X 135 X 305 mm
WEIGHT	2.32 KG
SHOT PER FUEL CELL	CA. 1100
SHOT BEFORE RECHARGING	CA. 8000

FASTENERS

LENGTH	25 - 64 mm
DIAMETER	1.8 mm
ANGLE	34 DEGREES

For all second fix and joinery tasks including wood ceiling, coving, skirting, glazing beads etc.

KEY PRODUCT FEATURES



- + Li-ion battery - approx. 8000 shots per charge
- + Battery indicator
- + Quick removal of 'trapped' brad
- + Adjustable depth control
- + Rear two-step loading
- + Belt hook and non slip grip
- + No-mark nose

CONSUMABLES

PART #	PRODUCT DESCRIPTION	PACK SIZE	FINISH
FNZ-842525	15G DA ANGLE BRAD 25 mm	4000	GALV
FNZ-842532	15G DA ANGLE BRAD 32 mm	4000	GALV
FNZ-842538	15G DA ANGLE BRAD 38 mm	4000	GALV
FNZ-842545	15G DA ANGLE BRAD 45 mm	4000	GALV
FNZ-842550	15G DA ANGLE BRAD 50 mm	4000	GALV
FNZ-842564	15G DA ANGLE BRAD 64 mm	4000	GALV
FNZ-842526	15G DA ANGLE BRAD 25 mm	4000	STAINLESS STEEL
FNZ-842533	15G DA ANGLE BRAD 32 mm	4000	STAINLESS STEEL
FNZ-842539	15G DA ANGLE BRAD 38 mm	4000	STAINLESS STEEL
FNZ-842551	15G DA ANGLE BRAD 50 mm	4000	STAINLESS STEEL
FNZ-842565	15G DA ANGLE BRAD 64 mm	4000	STAINLESS STEEL

TJEP CP-40 GAS NAILER

CORDLESS CONCRETE NAILER

SPECIFICATIONS

PART #	FNZ-100245
EAN NO.	5702551002452
TYPE	GAS NAILER
SIZE (L W H)	327 X 130 X 385 mm
WEIGHT	3.8 KG
SHOT PER FUEL CELL	CA. 1100
SHOT BEFORE RECHARGING	CA. 8000

FASTENERS

LENGTH	15 - 40 mm
DIAMETER	2.6 - 3.0 mm

Tjep CP-40 gas 3G for concrete nails. The 3rd generation gas nailer from TJEP. New design with proven mechanism, now with 7.2 V Li-ion battery. Gas nailer with high impact force for attaching bottom plate steel frames to concrete, floor and ceiling on concrete, steel, stone and plaster. Requires no cable, hose or compressor. Full flexibility without compromising on quality.

Simply insert the battery and gas and you're ready to go. Rubber collar protects against concrete splinters.

CONSUMABLES

PART #	PRODUCT DESCRIPTION	PACK SIZE	FINISH
FNZ-839220	20 mm CONCRETE/STEEL PIN TJEP	500	GALV
FNZ-839299	30 mm CONCRETE/STEEL PIN TJEP	500	GALV
FNZ-839295	40 mm CONCRETE/STEEL PIN TJEP	500	GALV



KEY PRODUCT FEATURES

- + Lightweight and compact
- + Short magazine for approx. 20 concrete nails

6 COLLATED NAILS AND TOOLS

TJEP ST-15/50 GAS 3G FINISH NAILER CORDLESS 15G STRAIGHT BRADDER

SPECIFICATIONS

PART #	FNZ-100240
EAN NO.	5702551002407
TYPE	GAS NAILER
SIZE (L W H)	350 X 86 X 286 mm
WEIGHT	1.10 KG
SHOT PER FUEL CELL	CA. 1100
SHOT BEFORE RECHARGING	CA. 8000

FASTENERS

LENGTH	15 - 50 mm
DIAMETER	1.8 mm

The 3rd generation gas nailer from TJEP. New design with proven mechanism, now with 7.2 V Li-ion battery technology for professional installation of skirting and scotia boards in concrete or steel framed walls with hardened steel brads etc.



KEY PRODUCT FEATURES

- + No-mark nose
- + Safety bracket integrate in nose
- + Adjustable depth control
- + Non-slip grip
- + Rafter/belt hook

CONSUMABLES

PART #	PRODUCT DESCRIPTION	PACK SIZE	FINISH
FNZ-842230	30 mm ST-50 FN STRAIGHT HARDENED FINISH NAIL	3000	GALV
FNZ-842240	40 mm ST-50 FN STRAIGHT HARDENED FINISH NAILS	3000	GALV
FNZ-842250	50 mm ST-50 FN STRAIGHT HARDENED FINISH NAILS	3000	GALV
FNZ-842262	ASSORTMENT 400 OF EA 20, 25, 30, 35, 40 & 50 mm ST-50 FN STRAIGHT FINISH NAILS,	2400	GALV

TJEP KA 4060 GAS 3G PRODUCT NAILER

CORDLESS PRODUCT NAILER



SPECIFICATIONS

PART #	FNZ-100255
EAN NO.	5702551002551
TYPE	GAS NAILER
SIZE (L W H)	425 X 108 X 393 mm
WEIGHT	4.02 KG
SHOT PER FUEL CELL	CA. 1100
SHOT BEFORE RECHARGING	CA. 8000

FASTENERS

LENGTH	40 - 60 mm
DIAMETER	4.0 mm
ANGLE	34 DEGREES

With this gas-powered anchor nailer you will quickly get started with your task. Insert batteries and fuel cell in the tool - and you are ready to work! No compressor means high freedom of movement.

KEY PRODUCT FEATURES



- + Precise insertion in nail plates & joist hangers
- + Non-slip grip – extremely low recoil
- + Adjustable depth control
- + Rafter/belt hook
- + Rear two-step loading

CONSUMABLES

PART #	PRODUCT DESCRIPTION	PACK SIZE	FINISH
FNZ-JH38G	3.30 X 38 mm COLLATED JOIST HANGER NAIL	3000	GALV
FNZ-JHSS-3338	3.30 X 38 mm COLLATED JOIST HANGER NAIL	1000	STAINLESS

6 COLLATED NAILS AND TOOLS

TJEP PQZ-75 GAS 3G STAPLER CORDLESS Q AND N TYPE STAPLER

SPECIFICATIONS

PART #	FNZ-100265
EAN NO.	5702551002650
TYPE	GAS STAPLER
SIZE (L W H)	375 X 108 X 351 mm
WEIGHT	3.96 KG
SHOT PER FUEL CELL	CA. 1100
SHOT BEFORE RECHARGING	CA. 8000

FASTENERS

LENGTH	35 - 75 mm	
WIDTH	Q SERIES STAPLE N SERIES STAPLE	PQ: 11.3 mm PZ: 10.8 mm
DIAMETER	Q SERIES STAPLE N SERIES STAPLE	PQ: 1.9 × 1.7 mm PZ: 1.6 × 1.4 mm

Gas stapler for both PQ and PZ staples. High power and adjustable depth control ensures perfect insertion of staples up to 75 mm long.



KEY PRODUCT FEATURES

- + Great balance
- + Non-slip grip – extremely low recoil
- + Adjustable depth control
- + Top load
- + Smooth no-mark nose
- + Belt hook

CONSUMABLES

PART #	PRODUCT DESCRIPTION	PACK SIZE	FINISH
FNZ-6512PG	SPOTNAIL Q SERIES STAPLE 38 mm	5000	GALV
FNZ-6516PG	SPOTNAIL Q SERIES STAPLE 50 mm	5000	GALV
FNZ-6520PG	SPOTNAIL Q SERIES STAPLE 63 mm	5000	GALV
FNZ-6612	SPOTNAIL N SERIES STAPLE 38 mm	10000	GALV
FNZ-6616PG	SPOTNAIL N SERIES STAPLE 50 mm	10000	GALV
FNZ-6616PS	SPOTNAIL N SERIES STAPLE 50 mm	10000	STAINLESS STEEL
FNZ-NI7SS10K	38 mm N SERIES STAPLE SS304 DIVERGENT POINT	10000	STAINLESS STEEL

TJEP FS-40 GAS 3G FENCING STAPLER

CORDLESS FENCING STAPLER

SPECIFICATIONS

PART #	FNZ-100260
EAN NO.	5702551002605
TYPE	GAS NAILER
SIZE (L W H)	373 X 108 X 356 mm
WEIGHT	3.93 KG
SHOT PER FUEL CELL	CA. 1100
SHOT BEFORE RECHARGING	CA. 8000

FASTENERS

LENGTH	25 - 40 mm
DIAMETER	12.8 mm
WIDTH	3.15 mm

Gas-powered stapler for fastening of wire fences etc. Perfect for the demanding tasks, and no need for compressors and hoses. The stapler is well-balanced and extremely powerful, ensuring perfect insertion, even in hardwood. Depth of drive can be adjusted, so the staple can be inserted fully or allowed some clearance (extra nose for mounting in hard wood is included).



KEY PRODUCT FEATURES

- + Great balance
- + Non-slip grip – extremely low recoil
- + Adjustable depth control
- + Top load
- + Smooth no-mark nose
- + Belt hook

CONSUMABLES

PART #	PRODUCT DESCRIPTION	PACK SIZE	FINISH
FNZ-841988	FENCING STAPLE 33 mm	1500	GALV
FNZ-841990	FENCING STAPLE 40 mm	1500	GALV

6 COLLATED NAILS AND TOOLS

TJEP CR 5/9 – 24 BATTERY CORDLESS C-RINGER

CORDLESS C-RINGER

SPECIFICATIONS

PART #	FNZ-115993
EAN NO.	5702551159934
TYPE	C - RINGER
SIZE (L W H)	344 X 203 X 249 mm
WEIGHT	2.58 KG
THICKNESS	5 - 9 mm

FASTENERS

WIDTH	24 mm
DIAMETER	1.8 mm

New! Battery powered cordless C Ring (Hog Ring) tool by TJEP. Fasten hog rings to chain link or wire mesh with no manual effort. Greatly increase the speed of your next job.

The CR 5/9 comes with two li-ion batteries, carrying case, and wall charger. Collated hog rings available in stainless steel or galvanised.



USED FOR

- + Car seats
- + Poultry cages
- + Traps
- + Mattresses
- + Insulation wire
- + Wire fencing

CONSUMABLES

PART #	PRODUCT DESCRIPTION	PACK SIZE	FINISH
FNZ-115996	1.8 C RINGS C24 23.7 mm HOG CLIP HD GALV	10,000	GALV
FNZ-C24SS	1.8 C RINGS C24 23.7 mm HOG CLIP SS 304	5000	STAINLESS STEEL

TJEP ACCESSORIES

TJEP FUEL CELLS



TJEP ALL-SEASON FUEL CELL RED RING

PART #	FNZ-100856
EAN NO.	5702551008560
HEIGHT	165 mm
QUANTITY	12 PCS.
SHOT	CA. 1,100 PCS.



TJEP ALL-SEASON FUEL CELL PURPLE RING*

PART #	FNZ-100864
EAN NO.	5702551008645
HEIGHT	165 mm
QUANTITY	12 PCS.
SHOT	CA. 1,000 PCS.

*EXTRA POWER FOR 100 mm FRAMER



TJEP FUEL CELL YELLOW RING

PART #	FNZ-100881
EAN NO.	5702551008812
HEIGHT	78 mm
QUANTITY	12 PCS.
SHOT	CA. 1,100 PCS.



TJEP CLEANER

PART #	FNZ-100890
EAN NO.	5702551008904
CONTENTS	500 ML
QUANTITY	12 PCS.
SHOT	CA. 1,100 PCS.



DEPENDABLE FASTENERS FOR YOUR PROJECTS

Fortress Fasteners Enquiries

0800 42 52 62 | sales@steelandtube.co.nz | steelandtube.co.nz

7

SOCKET SCREWS



7 SOCKET SCREWS

CAP SCREWS 12.9

BLACK ZINC PLATED

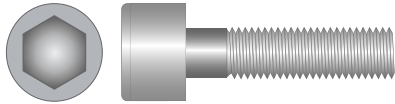

PART #	PART #	SIZE	PACK QTY
CAPM25	CAPM25Z	M2 X 5	100
CAPM210	CAPM210Z	M2 X 10	100
CAPM35	CAPM35Z	M3 X 5	100
CAPM36	CAPM36Z	M3 X 6	100
CAPM38	CAPM38Z	M3 X 8	100
CAPM310	CAPM310Z	M3 X 10	100
CAPM312	CAPM312Z	M3 X 12	100
CAPM316	CAPM316Z	M3 X 16	100
CAPM320	CAPM320Z	M3 X 20	100
CAPM325	CAPM325Z	M3 X 25	100
CAPM330	CAPM330Z	M3 X 30	100
CAPM335	CAPM335Z	M3 X 35	100
CAPM45	CAPM45Z	M4 X 5	100
CAPM46	CAPM46Z	M4 X 6	100
CAPM48	CAPM48Z	M4 X 8	100
CAPM410	CAPM410Z	M4 X 10	100
CAPM412	CAPM412Z	M4 X 12	100
CAPM416	CAPM416Z	M4 X 16	100
CAPM420	CAPM420Z	M4 X 20	100
CAPM425	CAPM425Z	M4 X 25	100
CAPM430	CAPM430Z	M4 X 30	100
CAPM435	CAPM435Z	M4 X 35	100
CAPM440	CAPM440Z	M4 X 40	100
CAPM445	CAPM445Z	M4 X 45	100
CAPM450	CAPM450Z	M4 X 50	100
CAPM56	CAPM56Z	M5 X 6	100
CAPM58	CAPM58Z	M5 X 8	100
CAPM510	CAPM510Z	M5 X 10	100
CAPM512	CAPM512Z	M5 X 12	100
CAPM516	CAPM516Z	M5 X 16	100
CAPM520	CAPM520Z	M5 X 20	100
CAPM525	CAPM525Z	M5 X 25	100

PART #	PART #	SIZE	PACK QTY
CAPM530	CAPM530Z	M5 X 30	100
CAPM535	CAPM535Z	M5 X 35	100
CAPM540	CAPM540Z	M5 X 40	100
CAPM545	CAPM545Z	M5 X 45	100
CAPM550	CAPM550Z	M5 X 50	100
CAPM555	CAPM555Z	M5 X 55	100
CAPM560	CAPM560Z	M5 X 60	100
CAPM565	CAPM565Z	M5 X 65	100
CAPM570	CAPM570Z	M5 X 70	100
CAPM580	CAPM580Z	M5 X 80	100
CAPM590	CAPM590Z	M5 X 90	100
CAPM5100	CAPM5100Z	M5 X 100	100
CAPM5110	CAPM5110Z	M5 X 110	100
CAPM5120	CAPM5120Z	M5 X 120	100
CAPM68	CAPM68Z	M6 X 8	100
CAPM610	CAPM610Z	M6 X 10	100
CAPM612	CAPM612Z	M6 X 12	100
CAPM616	CAPM616Z	M6 X 16	100
CAPM620	CAPM620Z	M6 X 20	100
CAPM625	CAPM625Z	M6 X 25	100
CAPM630	CAPM630Z	M6 X 30	100
CAPM635	CAPM635Z	M6 X 35	100
CAPM640	CAPM640Z	M6 X 40	100
CAPM645	CAPM645Z	M6 X 45	100
CAPM650	CAPM650Z	M6 X 50	100
CAPM655	CAPM655Z	M6 X 55	100
CAPM660	CAPM660Z	M6 X 60	100
CAPM665	CAPM665Z	M6 X 65	100
CAPM670	CAPM670Z	M6 X 70	100
CAPM675	CAPM675Z	M6 X 75	100
CAPM680	CAPM680Z	M6 X 80	100
CAPM690	CAPM690Z	M6 X 90	100

PART #	PART #	SIZE	PACK QTY
CAPM6100	CAPM6100Z	M6 X 100	100
CAPM6110	CAPM6110Z	M6 X 110	100
CAPM6120	CAPM6120Z	M6 X 120	100
CAPM6160	CAPM6160Z	M6 X 160	100
CAPM810	CAPM810Z	M8 X 10	100
CAPM812	CAPM812Z	M8 X 12	100
CAPM816	CAPM816Z	M8 X 16	100
CAPM820	CAPM820Z	M8 X 20	100
CAPM825	CAPM825Z	M8 X 25	100
CAPM830	CAPM830Z	M8 X 30	100
CAPM835	CAPM835Z	M8 X 35	50
CAPM840	CAPM840Z	M8 X 40	50
CAPM845	CAPM845Z	M8 X 45	50
CAPM850	CAPM850Z	M8 X 50	50
CAPM855	CAPM855Z	M8 X 55	50
CAPM860	CAPM860Z	M8 X 60	25
CAPM865	CAPM865Z	M8 X 65	25
CAPM870	CAPM870Z	M8 X 70	25
CAPM875	CAPM875Z	M8 X 75	25
CAPM880	CAPM880Z	M8 X 80	25
CAPM890	CAPM890Z	M8 X 90	25
CAPM8100	CAPM8100Z	M8 X 100	25
CAPM8110	CAPM8110Z	M8 X 110	25
CAPM8140	CAPM8140Z	M8 X 140	25
CAPM8150	CAPM8150Z	M8 X 150	25
CAPM8180	CAPM8180Z	M8 X 180	25
CAPM8200	CAPM8200Z	M8 X 200	25
CAPM1010	CAPM1010Z	M10 X 10	100
CAPM1012	CAPM1012Z	M10 X 12	100
CAPM1016	CAPM1016Z	M10 X 16	100
CAPM1020	CAPM1020Z	M10 X 20	100
CAPM1025	CAPM1025Z	M10 X 25	100

PART #	PART #	SIZE	PACK QTY
CAPM1030	CAPM1030Z	M10 X 30	100
CAPM1035	CAPM1035Z	M10 X 35	100
CAPM1040	CAPM1040Z	M10 X 40	100
CAPM1045	CAPM1045Z	M10 X 45	100
CAPM1050	CAPM1050Z	M10 X 50	50
CAPM1055	CAPM1055Z	M10 X 55	50
CAPM1060	CAPM1060Z	M10 X 60	50
CAPM1065	CAPM1065Z	M10 X 65	50
CAPM1070	CAPM1070Z	M10 X 70	50
CAPM1075	CAPM1075Z	M10 X 75	25
CAPM1080	CAPM1080Z	M10 X 80	25
CAPM1090	CAPM1090Z	M10 X 90	25
CAPM10100	CAPM10100Z	M10 X 100	25
CAPM10110	CAPM10110Z	M10 X 110	25
CAPM10120	CAPM10120Z	M10 X 120	25
CAPM10130	CAPM10130Z	M10 X 130	25
CAPM10140	CAPM10140Z	M10 X 140	25
CAPM10150	CAPM10150Z	M10 X 150	25
CAPM1212	CAPM1212Z	M12 X 12	100
CAPM1216	CAPM1216Z	M12 X 16	100
CAPM1220	CAPM1220Z	M12 X 20	100
CAPM1225	CAPM1225Z	M12 X 25	100
CAPM1230	CAPM1230Z	M12 X 30	100
CAPM1235	CAPM1235Z	M12 X 35	50
CAPM1240	CAPM1240Z	M12 X 40	50
CAPM1245	CAPM1245Z	M12 X 45	50
CAPM1250	CAPM1250Z	M12 X 50	50
CAPM1255	CAPM1255Z	M12 X 55	50
CAPM1260	CAPM1260Z	M12 X 60	25
CAPM1265	CAPM1265Z	M12 X 65	25
CAPM1270	CAPM1270Z	M12 X 70	25
CAPM1275	CAPM1275Z	M12 X 75	25

7 SOCKET SCREWS

CAP SCREWS 12.9

BLACK ZINC PLATED

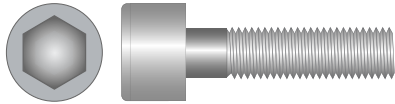

PART #	PART #	SIZE	PACK QTY
CAPM1280	CAPM1280Z	M12 X 80	25
CAPM1290	CAPM1290Z	M12 X 90	25
CAPM12100	CAPM12100Z	M12 X 100	25
CAPM12110	CAPM12110Z	M12 X 110	25
CAPM12120	CAPM12120Z	M12 X 120	25
CAPM12130	CAPM12130Z	M12 X 130	25
CAPM12140	CAPM12140Z	M12 X 140	25
CAPM12150	CAPM12150Z	M12 X 150	25
CAPM12160	CAPM12160Z	M12 X 160	25
CAPM12180	CAPM12180Z	M12 X 180	25
CAPM12190	CAPM12190Z	M12 X 190	25
CAPM12200	CAPM12200Z	M12 X 200	25
CAPM12220	CAPM12220Z	M12 X 220	25
CAPM1425	CAPM1425Z	M14 X 25	50
CAPM1430	CAPM1430Z	M14 X 30	50
CAPM1440	CAPM1440Z	M14 X 40	50
CAPM1445	CAPM1445Z	M14 X 45	50
CAPM1450	CAPM1450Z	M14 X 50	50
CAPM1455	CAPM1455Z	M14 X 55	25
CAPM1460	CAPM1460Z	M14 X 60	25
CAPM1470	CAPM1470Z	M14 X 70	25
CAPM1475	CAPM1475Z	M14 X 75	25
CAPM1480	CAPM1480Z	M14 X 80	25
CAPM1490	CAPM1490Z	M14 X 90	25
CAPM14100	CAPM14100Z	M14 X 100	25
CAPM14110	CAPM14110Z	M14 X 110	25
CAPM14120	CAPM14120Z	M14 X 120	25
CAPM1625	CAPM1625Z	M16 X 25	50
CAPM1630	CAPM1630Z	M16 X 30	50
CAPM1635	CAPM1635Z	M16 X 35	50
CAPM1640	CAPM1640Z	M16 X 40	50

PART #	PART #	SIZE	PACK QTY
CAPM1645	CAPM1645Z	M16 X 45	50
CAPM1650	CAPM1650Z	M16 X 50	50
CAPM1655	CAPM1655Z	M16 X 55	50
CAPM1660	CAPM1660Z	M16 X 60	25
CAPM1665	CAPM1665Z	M16 X 65	25
CAPM1670	CAPM1670Z	M16 X 70	25
CAPM1675	CAPM1675Z	M16 X 75	25
CAPM1680	CAPM1680Z	M16 X 80	25
CAPM1690	CAPM1690Z	M16 X 90	25
CAPM16100	CAPM16100Z	M16 X 100	25
CAPM16110	CAPM16110Z	M16 X 110	25
CAPM16120	CAPM16120Z	M16 X 120	25
CAPM16130	CAPM16130Z	M16 X 130	25
CAPM16140	CAPM16140Z	M16 X 140	25
CAPM16150	CAPM16150Z	M16 X 150	25
CAPM16160	CAPM16160Z	M16 X 160	25
CAPM16180	CAPM16180Z	M16 X 180	25
CAPM16200	CAPM16200Z	M16 X 200	25
CAPM2030	CAPM2030Z	M20 X 30	25
CAPM2035	CAPM2035Z	M20 X 35	25
CAPM2040	CAPM2040Z	M20 X 40	25
CAPM2045	CAPM2045Z	M20 X 45	25
CAPM2050	CAPM2050Z	M20 X 50	25
CAPM2055	CAPM2055Z	M20 X 55	10
CAPM2060	CAPM2060Z	M20 X 60	10
CAPM2065	CAPM2065Z	M20 X 65	10
CAPM2070	CAPM2070Z	M20 X 70	10
CAPM2075	CAPM2075Z	M20 X 75	10
CAPM2080	CAPM2080Z	M20 X 80	10
CAPM2090	CAPM2090Z	M20 X 90	10
CAPM20100	CAPM20100Z	M20 X 100	10

PART #	PART #	SIZE	PACK QTY
CAPM20110	CAPM20110Z	M20 X 110	10
CAPM20120	CAPM20120Z	M20 X 120	10
CAPM20130	CAPM20130Z	M20 X 130	10
CAPM20140	CAPM20140Z	M20 X 140	10
CAPM20150	CAPM20150Z	M20 X 150	10
CAPM20180	CAPM20180Z	M20 X 180	10
CAPM20200	CAPM20200Z	M20 X 200	10
CAPM2440	CAPM2440Z	M24 X 40	10
CAPM2450	CAPM2450Z	M24 X 50	10
CAPM2460	CAPM2460Z	M24 X 60	10
CAPM2475	CAPM2475Z	M24 X 75	10
CAPM2480	CAPM2480Z	M24 X 80	10
CAPM2490	CAPM2490Z	M24 X 90	10
CAPM24100	CAPM24100Z	M24 X 100	10
CAPM24120	CAPM24120Z	M24 X 120	10
CAPM24130	CAPM24130Z	M24 X 130	10
CAPM24140	CAPM24140Z	M24 X 140	10
CAPM24150	CAPM24150Z	M24 X 150	10
CAPM24160	CAPM24160Z	M24 X 160	10
CAPM24180	CAPM24180Z	M24 X 180	10
CAPM24200	CAPM24200Z	M24 X 200	10
CAPM27100	CAPM27100Z	M27 X 100	5
CAPM3080	CAPM3080Z	M30 X 80	5
CAPM3090	CAPM3090Z	M30 X 90	5
CAPM30100	CAPM30100Z	M30 X 100	5
CAPM30110	CAPM30110Z	M30 X 110	5
CAPM30120	CAPM30120Z	M30 X 120	5
CAPM30130	CAPM30130Z	M30 X 130	5
CAPM30140	CAPM30140Z	M30 X 140	5
CAPM30150	CAPM30150Z	M30 X 150	5
CAPM30180	CAPM30180Z	M30 X 180	5

PART #	PART #	SIZE	PACK QTY
CAPM30200	CAPM30200Z	M30 X 200	5
CAPM36100	CAPM36100Z	M36 X 100	5
CAPM36120	CAPM36120Z	M36 X 120	5
CAPM36130	CAPM36130Z	M36 X 130	5
CAPM36140	CAPM36140Z	M36 X 140	5
CAPM36150	CAPM36150Z	M36 X 150	5
CAPM36180	CAPM36180Z	M36 X 180	5
CAPM36200	CAPM36200Z	M36 X 200	5

7 SOCKET SCREWS

CAP SCREWS 12.9

BLACK - IMPERIAL

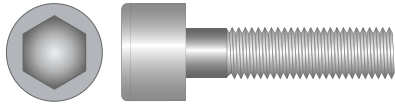

PART #	SIZE	PACK QTY
CAP141	1/4 X 1"	100
CAP1412	1/4 X 1/2	100
CAP142	1/4 X 2"	100
CAP143	1/4 X 3"	100
CAP1434	1/4 X 3/4	100
CAP1458	1/4 X 5/8	100
CAP14112	1/4 X 1-1/2	100
CAP14114	1/4 X 1-1/4	100
CAP14134	1/4 X 1-3/4	100
CAP14212	1/4 X 2-1/2	100
CAP14214	1/4 X 2-1/4	100
CAP5161	5/16 X 1"	50
CAP5162	5/16 X 2"	100
CAP5163	5/16 X 3"	100
CAP516112	5/16 X 1-1/2	100
CAP516114	5/16 X 1-1/4	100
CAP51612	5/16 X 1/2	100
CAP516134	5/16 X 1-3/4	100
CAP516212	5/16 X 2-1/2	100
CAP51634	5/16 X 3/4	100
CAP3812	3/8 X 1/2	100
CAP382	3/8 X 2"	100
CAP383	3/8 X 3"	50
CAP3834	3/8 X 3/4"	50
CAP384	3/8 X 4"	100
CAP38112	3/8 X 1-1/2	50
CAP38114	3/8 X 1-1/4	50
CAP38134	3/8 X 1-3/4	50
CAP38212	3/8 X 2-1/2	50
CAP38214	3/8 X 2-1/4	50
CAP38312	3/8 X 3 1/2	50
CAP38314	3/8 X 3 1/4	50

PART #	SIZE	PACK QTY
CAP7161	7/16 X 1"	25
CAP716112	7/16 X 1-1/2	100
CAP716114	7/16 X 1-1/4	100
CAP716134	7/16 X 1-3/4	100
CAP7162	7/16 X 2"	100
CAP141	1/4 X 1"	100
CAP1412	1/4 X 1/2	100
CAP142	1/4 X 2"	100
CAP143	1/4 X 3"	100
CAP1434	1/4 X 3/4	100
CAP1458	1/4 X 5/8	100
CAP14112	1/4 X 1-1/2	100
CAP14114	1/4 X 1-1/4	100
CAP14134	1/4 X 1-3/4	100
CAP14212	1/4 X 2-1/2	100
CAP14214	1/4 X 2-1/4	100
CAP5161	5/16 X 1"	50
CAP5162	5/16 X 2"	100
CAP5163	5/16 X 3"	100
CAP516112	5/16 X 1-1/2	100
CAP516114	5/16 X 1-1/4	100
CAP51612	5/16 X 1/2	100
CAP516134	5/16 X 1-3/4	100
CAP516212	5/16 X 2-1/2	100
CAP51634	5/16 X 3/4	100
CAP3812	3/8 X 1/2	100
CAP382	3/8 X 2"	100
CAP383	3/8 X 3"	50
CAP3834	3/8 X 3/4"	50
CAP384	3/8 X 4"	100
CAP38112	3/8 X 1-1/2	50

PART #	SIZE	PACK QTY
CAP38114	3/8 X 1-1/4	50
CAP38134	3/8 X 1-3/4	50
CAP38212	3/8 X 2-1/2	50
CAP38214	3/8 X 2-1/4	50
CAP38312	3/8 X 3 1/2	50
CAP38314	3/8 X 3 1/4	50
CAP7161	7/16 X 1"	25
CAP716112	7/16 X 1-1/2	100
CAP716114	7/16 X 1-1/4	100
CAP716134	7/16 X 1-3/4	100
CAP7162	7/16 X 2"	100

7 SOCKET SCREWS

CAP SCREWS

STAINLESS STEEL T304 STAINLESS STEEL T316

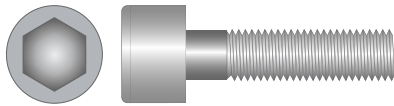

PART #	PART #	SIZE	PACK QTY
CAPXM210	CAPXM210T	M2 X 10	200
CAPXM36	CAPXM36T	M3 X 6	200
CAPXM38	CAPXM38T	M3 X 8	200
CAPXM310	CAPXM310T	M3 X 10	200
CAPXM312	CAPXM312T	M3 X 12	200
CAPXM316	CAPXM316T	M3 X 16	200
CAPXM320	CAPXM320T	M3 X 20	200
CAPXM325	CAPXM325T	M3 X 25	200
CAPXM330	CAPXM330T	M3 X 30	200
CAPXM46	CAPXM46T	M4 X 6	200
CAPXM48	CAPXM48T	M4 X 8	200
CAPXM410	CAPXM410T	M4 X 10	200
CAPXM412	CAPXM412T	M4 X 12	200
CAPXM416	CAPXM416T	M4 X 16	200
CAPXM420	CAPXM420T	M4 X 20	200
CAPXM425	CAPXM425T	M4 X 25	200
CAPXM430	CAPXM430T	M4 X 30	200
CAPXM435	CAPXM435T	M4 X 35	200
CAPXM440	CAPXM440T	M4 X 40	200
CAPXM450	CAPXM450T	M4 X 50	200
CAPXM56	CAPXM56T	M5 X 6	200
CAPXM58	CAPXM58T	M5 X 8	200
CAPXM510	CAPXM510T	M5 X 10	200
CAPXM512	CAPXM512T	M5 X 12	200
CAPXM516	CAPXM516T	M5 X 16	200
CAPXM520	CAPXM520T	M5 X 20	200
CAPXM525	CAPXM525T	M5 X 25	200
CAPXM530	CAPXM530T	M5 X 30	200
CAPXM535	CAPXM535T	M5 X 35	200
CAPXM540	CAPXM540T	M5 X 40	200
CAPXM545	CAPXM545T	M5 X 45	200

PART #	PART #	SIZE	PACK QTY
CAPXM550	CAPXM550T	M5 X 50	200
CAPXM560	CAPXM560T	M5 X 60	100
CAPXM570	CAPXM570T	M5 X 70	100
CAPXM580	CAPXM580T	M5 X 80	100
CAPXM66	CAPXM66T	M6 X 6	200
CAPXM68	CAPXM68T	M6 X 8	200
CAPXM610	CAPXM610T	M6 X 10	200
CAPXM612	CAPXM612T	M6 X 12	200
CAPXM616	CAPXM616T	M6 X 16	200
CAPXM620	CAPXM620T	M6 X 20	200
CAPXM625	CAPXM625T	M6 X 25	200
CAPXM630	CAPXM630T	M6 X 30	100
CAPXM635	CAPXM635T	M6 X 35	100
CAPXM640	CAPXM640T	M6 X 40	100
CAPXM645	CAPXM645T	M6 X 45	100
CAPXM650	CAPXM650T	M6 X 50	100
CAPXM655	CAPXM655T	M6 X 55	100
CAPXM660	CAPXM660T	M6 X 60	100
CAPXM670	CAPXM670T	M6 X 70	100
CAPXM675	CAPXM675T	M6 X 75	100
CAPXM680	CAPXM680T	M6 X 80	100
CAPXM690	CAPXM690T	M6 X 90	100
CAPXM812	CAPXM812T	M8 X 12	200
CAPXM816	CAPXM816T	M8 X 16	200
CAPXM820	CAPXM820T	M8 X 20	200
CAPXM825	CAPXM825T	M8 X 25	200
CAPXM830	CAPXM830T	M8 X 30	200
CAPXM835	CAPXM835T	M8 X 35	200
CAPXM840	CAPXM840T	M8 X 40	200
CAPXM845	CAPXM845T	M8 X 45	200
CAPXM850	CAPXM850T	M8 X 50	200

PART #	PART #	SIZE	PACK QTY
CAPXM855	CAPXM855T	M8 X 55	100
CAPXM860	CAPXM860T	M8 X 60	100
CAPXM865	CAPXM865T	M8 X 65	100
CAPXM870	CAPXM870T	M8 X 70	100
CAPXM880	CAPXM880T	M8 X 80	100
CAPXM890	CAPXM890T	M8 X 90	100
CAPXM8100	CAPXM8100T	M8 X 100	100
CAPXM8120	CAPXM8120T	M8 X 120	100
CAPXM1016	CAPXM1016T	M10 X 16	100
CAPXM1020	CAPXM1020T	M10 X 20	100
CAPXM1025	CAPXM1025T	M10 X 25	100
CAPXM1030	CAPXM1030T	M10 X 30	100
CAPXM1035	CAPXM1035T	M10 X 35	100
CAPXM1040	CAPXM1040T	M10 X 40	100
CAPXM1045	CAPXM1045T	M10 X 45	100
CAPXM1050	CAPXM1050T	M10 X 50	100
CAPXM1060	CAPXM1060T	M10 X 60	100
CAPXM1065	CAPXM1065T	M10 X 65	100
CAPXM1070	CAPXM1070T	M10 X 70	50
CAPXM1080	CAPXM1080T	M10 X 80	50
CAPXM1090	CAPXM1090T	M10 X 90	50
CAPXM10100	CAPXM10100T	M10 X 100	50
CAPXM10110	CAPXM10110T	M10 X 110	50
CAPXM10130	CAPXM10130T	M10 X 130	50
CAPXM1225	CAPXM1225T	M12 X 25	100
CAPXM1230	CAPXM1230T	M12 X 30	100
CAPXM1235	CAPXM1235T	M12 X 35	100
CAPXM1240	CAPXM1240T	M12 X 40	100
CAPXM1245	CAPXM1245T	M12 X 45	100
CAPXM1250	CAPXM1250T	M12 X 50	50
CAPXM1260	CAPXM1260T	M12 X 60	50

PART #	PART #	SIZE	PACK QTY
CAPXM1270	CAPXM1270T	M12 X 70	50
CAPXM1280	CAPXM1280T	M12 X 80	50
CAPXM1290	CAPXM1290T	M12 X 90	50
CAPXM12100	CAPXM12100T	M12 X 100	50
CAPXM12110	CAPXM12110T	M12 X 110	50
CAPXM12120	CAPXM12120T	M12 X 120	50
CAPXM1640	CAPXM1640T	M16 X 40	50
CAPXM1650	CAPXM1650T	M16 X 50	50
CAPXM1660	CAPXM1660T	M16 X 60	50
CAPXM2040	CAPXM2040T	M20 X 40	50
CAPXM2050	CAPXM2050T	M20 X 50	50

7 SOCKET SCREWS

BUTTON HEAD SOCKET SCREWS 12.9

BLACK ZINC PLATED

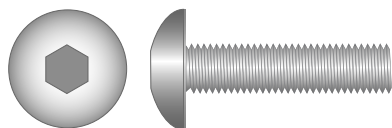

PART #	PART#	SIZE	PACK QTY
CAPBUTM25	CAPBUTM25Z	M2 X 5	100
CAPBUTM210	CAPBUTM210Z	M2 X 10	100
CAPBUTM35	CAPBUTM35Z	M3 X 5	100
CAPBUTM36	CAPBUTM36Z	M3 X 6	100
CAPBUTM38	CAPBUTM38Z	M3 X 8	100
CAPBUTM310	CAPBUTM310Z	M3 X 10	100
CAPBUTM312	CAPBUTM312Z	M3 X 12	100
CAPBUTM316	CAPBUTM316Z	M3 X 16	100
CAPBUTM320	CAPBUTM320Z	M3 X 20	100
CAPBUTM325	CAPBUTM325Z	M3 X 25	100
CAPBUTM330	CAPBUTM330Z	M3 X 30	100
CAPBUTM335	CAPBUTM335Z	M3 X 35	100
CAPBUTM45	CAPBUTM45Z	M4 X 5	100
CAPBUTM46	CAPBUTM46Z	M4 X 6	100
CAPBUTM48	CAPBUTM48Z	M4 X 8	100
CAPBUTM410	CAPBUTM410Z	M4 X 10	100
CAPBUTM412	CAPBUTM412Z	M4 X 12	100
CAPBUTM416	CAPBUTM416Z	M4 X 16	100
CAPBUTM420	CAPBUTM420Z	M4 X 20	100
CAPBUTM425	CAPBUTM425Z	M4 X 25	100
CAPBUTM430	CAPBUTM430Z	M4 X 30	100
CAPBUTM435		M4 X 35	100
CAPBUTM440	CAPBUTM440Z	M4 X 40	100
CAPBUTM445	CAPBUTM445Z	M4 X 45	100
CAPBUTM450	CAPBUTM450Z	M4 X 50	100
CAPBUTM58		M5 X 8	100
CAPBUTM510	CAPBUTM510Z	M5 X 10	100
CAPBUTM512	CAPBUTM512Z	M5 X 12	100
CAPBUTM516	CAPBUTM516Z	M5 X 16	100
CAPBUTM520	CAPBUTM520Z	M5 X 20	100
CAPBUTM525	CAPBUTM525Z	M5 X 25	100
CAPBUTM530	CAPBUTM530Z	M5 X 30	100

PART #	PART#	SIZE	PACK QTY
CAPBUTM535	CAPBUTM535Z	M5 X 35	100
CAPBUTM540	CAPBUTM540Z	M5 X 40	100
CAPBUTM545	CAPBUTM545Z	M5 X 45	100
CAPBUTM550	CAPBUTM550Z	M5 X 50	100
CAPBUTM555	CAPBUTM555Z	M5 X 55	50
CAPBUTM560	CAPBUTM560Z	M5 X 60	50
CAPBUTM565	CAPBUTM565Z	M5 X 65	50
CAPBUTM570	CAPBUTM570Z	M5 X 70	50
CAPBUTM580	CAPBUTM580Z	M5 X 80	50
CAPBUTM590	CAPBUTM590Z	M5 X 90	50
CAPBUTM5100	CAPBUTM5100Z	M5 X 100	50
CAPBUTM5110	CAPBUTM5110Z	M5 X 110	50
CAPBUTM5120	CAPBUTM5120Z	M5 X 120	50
CAPBUTM68	CAPBUTM68Z	M6 X 8	100
CAPBUTM610	CAPBUTM610Z	M6 X 10	100
CAPBUTM612	CAPBUTM612Z	M6 X 12	100
CAPBUTM616	CAPBUTM616Z	M6 X 16	100
CAPBUTM620	CAPBUTM620Z	M6 X 20	100
CAPBUTM625	CAPBUTM625Z	M6 X 25	100
CAPBUTM630	CAPBUTM630Z	M6 X 30	100
CAPBUTM635	CAPBUTM635Z	M6 X 35	100
CAPBUTM640	CAPBUTM640Z	M6 X 40	100
CAPBUTM645	CAPBUTM645Z	M6 X 45	100
CAPBUTM650	CAPBUTM650Z	M6 X 50	100
CAPBUTM655	CAPBUTM655Z	M6 X 55	100
CAPBUTM660	CAPBUTM660Z	M6 X 60	50
CAPBUTM665	CAPBUTM665Z	M6 X 65	50
CAPBUTM670	CAPBUTM670Z	M6 X 70	50
CAPBUTM675	CAPBUTM675Z	M6 X 75	50
CAPBUTM680	CAPBUTM680Z	M6 X 80	50
CAPBUTM690	CAPBUTM690Z	M6 X 90	50
CAPBUTM6100	CAPBUTM6100Z	M6 X 100	25

PART #	PART#	SIZE	PACK QTY
CAPBUTM6110	CAPBUTM6110Z	M6 X 110	25
CAPBUTM6120	CAPBUTM6120Z	M6 X 120	25
CAPBUTM6160	CAPBUTM6160Z	M6 X 160	25
CAPBUTM810	CAPBUTM810Z	M8 X 10	100
CAPBUTM812	CAPBUTM812Z	M8 X 12	100
CAPBUTM816	CAPBUTM816Z	M8 X 16	100
CAPBUTM820	CAPBUTM820Z	M8 X 20	100
CAPBUTM825	CAPBUTM825Z	M8 X 25	100
CAPBUTM830	CAPBUTM830Z	M8 X 30	100
CAPBUTM835	CAPBUTM835Z	M8 X 35	100
CAPBUTM840	CAPBUTM840Z	M8 X 40	100
CAPBUTM845	CAPBUTM845Z	M8 X 45	100
CAPBUTM850	CAPBUTM850Z	M8 X 50	100
CAPBUTM855	CAPBUTM855Z	M8 X 55	100
CAPBUTM860	CAPBUTM860Z	M8 X 60	50
CAPBUTM865	CAPBUTM865Z	M8 X 65	50
CAPBUTM870	CAPBUTM870Z	M8 X 70	50
CAPBUTM875	CAPBUTM875Z	M8 X 75	50
CAPBUTM880	CAPBUTM880Z	M8 X 80	50
CAPBUTM890	CAPBUTM890Z	M8 X 90	50
CAPBUTM8100	CAPBUTM8100Z	M8 X 100	25
CAPBUTM8110	CAPBUTM8110Z	M8 X 110	25
CAPBUTM8120	CAPBUTM8120Z	M8 X 120	25
CAPBUTM8110	CAPBUTM8110Z	M8 X 130	25
CAPBUTM8140	CAPBUTM8140Z	M8 X 140	25
CAPBUTM8150	CAPBUTM8150Z	M8 X 150	25
CAPBUTM1010	CAPBUTM1010Z	M10 X 10	100
CAPBUTM1012	CAPBUTM1012Z	M10 X 12	100
CAPBUTM1016	CAPBUTM1016Z	M10 X 16	100
CAPBUTM1020	CAPBUTM1020Z	M10 X 20	100
CAPBUTM1025	CAPBUTM1025Z	M10 X 25	100
CAPBUTM1030	CAPBUTM1030Z	M10 X 30	100

PART #	PART#	SIZE	PACK QTY
CAPBUTM1035	CAPBUTM1035Z	M10 X 35	100
CAPBUTM1040	CAPBUTM1040Z	M10 X 40	100
CAPBUTM1045	CAPBUTM1045Z	M10 X 45	100
CAPBUTM1050	CAPBUTM1050Z	M10 X 50	100
CAPBUTM1055	CAPBUTM1055Z	M10 X 55	50
CAPBUTM1060	CAPBUTM1060Z	M10 X 60	50
CAPBUTM1065	CAPBUTM1065Z	M10 X 65	50
CAPBUTM1070	CAPBUTM1070Z	M10 X 70	50
CAPBUTM1075	CAPBUTM1075Z	M10 X 75	50
CAPBUTM1080	CAPBUTM1080Z	M10 X 80	50
CAPBUTM1090	CAPBUTM1090Z	M10 X 90	50
CAPBUTM10100	CAPBUTM10100Z	M10 X 100	25
CAPBUTM10110	CAPBUTM10110Z	M10 X 110	25
CAPBUTM10120	CAPBUTM10120Z	M10 X 120	25
CAPBUTM10130	CAPBUTM10130Z	M10 X 130	25
CAPBUTM10140	CAPBUTM10140Z	M10 X 140	25
CAPBUTM10150	CAPBUTM10150Z	M10 X 150	25
CAPBUTM1212	CAPBUTM1212Z	M12 X 12	100
CAPBUTM1216	CAPBUTM1216Z	M12 X 16	100
CAPBUTM1220	CAPBUTM1220Z	M12 X 20	100
CAPBUTM1225	CAPBUTM1225Z	M12 X 25	100
CAPBUTM1230	CAPBUTM1230Z	M12 X 30	100
CAPBUTM1235	CAPBUTM1235Z	M12 X 35	100
CAPBUTM1240	CAPBUTM1240Z	M12 X 40	100
CAPBUTM1245	CAPBUTM1245Z	M12 X 45	100
CAPBUTM1250	CAPBUTM1250Z	M12 X 50	100
CAPBUTM1255	CAPBUTM1255Z	M12 X 55	50
CAPBUTM1260	CAPBUTM1260Z	M12 X 60	50
CAPBUTM1265	CAPBUTM1265Z	M12 X 65	50
CAPBUTM1270	CAPBUTM1270Z	M12 X 70	50
CAPBUTM1275	CAPBUTM1275Z	M12 X 75	50
CAPBUTM1280	CAPBUTM1280Z	M12 X 80	50

7 SOCKET SCREWS

BUTTON HEAD SOCKET SCREWS 12.9

BLACK ZINC PLATED

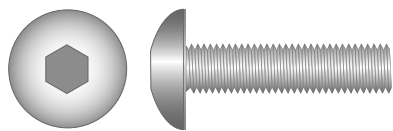

PART #	PART#	SIZE	PACK QTY
CAPBUTM1290	CAPBUTM1290Z	M12 X 90	50
CAPBUTM12100	CAPBUTM12100Z	M12 X 100	25
CAPBUTM12110	CAPBUTM12110Z	M12 X 110	25
CAPBUTM12120	CAPBUTM12120Z	M12 X 120	25
CAPBUTM12130	CAPBUTM12130Z	M12 X 130	25
CAPBUTM12140	CAPBUTM12140Z	M12 X 140	25
CAPBUTM12150	CAPBUTM12150Z	M12 X 150	25
CAPBUTM12160	CAPBUTM12160Z	M12 X 160	25
CAPBUTM12180	CAPBUTM12180Z	M12 X 180	25
CAPBUTM12190	CAPBUTM12190Z	M12 X 190	25
CAPBUTM12200	CAPBUTM12200Z	M12 X 200	25
CAPBUTM12220	CAPBUTM12220Z	M12 X 220	25
CAPBUTM1425	CAPBUTM1425Z	M14 X 25	50
CAPBUTM1430	CAPBUTM1430Z	M14 X 30	50
CAPBUTM1440	CAPBUTM1440Z	M14 X 40	50
CAPBUTM1445	CAPBUTM1445Z	M14 X 45	50
CAPBUTM1450	CAPBUTM1450Z	M14 X 50	50
CAPBUTM1455	CAPBUTM1455Z	M14 X 55	50
CAPBUTM1460	CAPBUTM1460Z	M14 X 60	50
CAPBUTM1470	CAPBUTM1470Z	M14 X 70	50
CAPBUTM1475	CAPBUTM1475Z	M14 X 75	50
CAPBUTM1480	CAPBUTM1480Z	M14 X 80	50
CAPBUTM1490	CAPBUTM1490Z	M14 X 90	50
CAPBUTM14100	CAPBUTM14100Z	M14 X 100	25
CAPBUTM1625	CAPBUTM1625Z	M16 X 25	50
CAPBUTM1630	CAPBUTM1630Z	M16 X 30	50
CAPBUTM1635	CAPBUTM1635Z	M16 X 35	50
CAPBUTM1640	CAPBUTM1640Z	M16 X 40	50
CAPBUTM1645	CAPBUTM1645Z	M16 X 45	50
CAPBUTM1650	CAPBUTM1650Z	M16 X 50	50
CAPBUTM1655	CAPBUTM1655Z	M16 X 55	50

PART #	PART#	SIZE	PACK QTY
CAPBUTM1660	CAPBUTM1660Z	M16 X 60	50
CAPBUTM1665	CAPBUTM1665Z	M16 X 65	50
CAPBUTM1670	CAPBUTM1670Z	M16 X 70	50
CAPBUTM1675	CAPBUTM1675Z	M16 X 75	50
CAPBUTM1680	CAPBUTM1680Z	M16 X 80	50
CAPBUTM1690	CAPBUTM1690Z	M16 X 90	50
CAPBUTM16100	CAPBUTM16100Z	M16 X 100	25
CAPBUTM16110	CAPBUTM16110Z	M16 X 110	25
CAPBUTM16120	CAPBUTM16120Z	M16 X 120	25
CAPBUTM16130	CAPBUTM16130Z	M16 X 130	25
CAPBUTM16140	CAPBUTM16140Z	M16 X 140	25
CAPBUTM16150	CAPBUTM16150Z	M16 X 150	25
CAPBUTM2030	CAPBUTM2030Z	M20 X 30	25
CAPBUTM2035	CAPBUTM2035Z	M20 X 35	25
CAPBUTM2040	CAPBUTM2040Z	M20 X 40	25
CAPBUTM2045	CAPBUTM2045Z	M20 X 45	25
CAPBUTM2050	CAPBUTM2050Z	M20 X 50	25
CAPBUTM2055	CAPBUTM2055Z	M20 X 55	25
CAPBUTM2060	CAPBUTM2060Z	M20 X 60	25
CAPBUTM2065	CAPBUTM2065Z	M20 X 65	25
CAPBUTM2070	CAPBUTM2070Z	M20 X 70	25
CAPBUTM2075	CAPBUTM2075Z	M20 X 75	25
CAPBUTM2080	CAPBUTM2080Z	M20 X 80	25
CAPBUTM2090	CAPBUTM2090Z	M20 X 90	25
CAPBUTM20100	CAPBUTM20100Z	M20 X 100	25
CAPBUTM20110	CAPBUTM20110Z	M20 X 110	25
CAPBUTM20120	CAPBUTM20120Z	M20 X 120	25
CAPBUTM20130	CAPBUTM20130Z	M20 X 130	25
CAPBUTM20140	CAPBUTM20140Z	M20 X 140	25
CAPBUTM20150	CAPBUTM20150Z	M20 X 150	25
CAPBUTM20180	CAPBUTM20180Z	M20 X 180	25

PART #	PART#	SIZE	PACK QTY
CAPBUTM20200	CAPBUTM20200Z	M20 X 200	10
CAPBUTM2440	CAPBUTM2440Z	M24 X 40	25
CAPBUTM2450	CAPBUTM2450Z	M24 X 50	25
CAPBUTM2460	CAPBUTM2460Z	M24 X 60	25
CAPBUTM2475	CAPBUTM2475Z	M24 X 75	25
CAPBUTM2480	CAPBUTM2480Z	M24 X 80	25
CAPBUTM2490	CAPBUTM2490Z	M24 X 90	25
CAPBUTM24100	CAPBUTM24100Z	M24 X 100	25
CAPBUTM24120	CAPBUTM24120Z	M24 X 120	25
CAPBUTM24130	CAPBUTM24130Z	M24 X 130	25
CAPBUTM24140	CAPBUTM24140Z	M24 X 140	25
CAPBUTM24150	CAPBUTM24150Z	M24 X 150	25
CAPBUTM24160	CAPBUTM24160Z	M24 X 160	25
CAPBUTM24180	CAPBUTM24180Z	M24 X 180	25
CAPBUTM24200	CAPBUTM24200Z	M24 X 200	10

7 SOCKET SCREWS

BUTTON HEAD SOCKET SCREWS

STAINLESS STEEL T304 STAINLESS STEEL T316

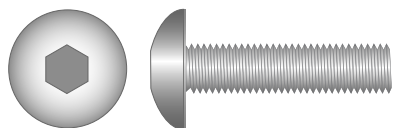

PART #	PART #	SIZE	PACK QTY
CAPBUTXM36	CAPBUTXM36T	M3 X 6	200
CAPBUTXM38	CAPBUTXM38T	M3 X 8	200
CAPBUTXM310	CAPBUTXM310T	M3 X 10	200
CAPBUTXM312	CAPBUTXM312T	M3 X 12	200
CAPBUTXM316	CAPBUTXM316T	M3 X 16	200
CAPBUTXM320	CAPBUTXM320T	M3 X 20	200
CAPBUTXM325	CAPBUTXM325T	M3 X 25	200
CAPBUTXM48	CAPBUTXM48T	M4 X 8	200
CAPBUTXM410	CAPBUTXM410T	M4 X 10	200
CAPBUTXM412	CAPBUTXM412T	M4 X 12	200
CAPBUTXM416	CAPBUTXM416T	M4 X 16	200
CAPBUTXM420	CAPBUTXM420T	M4 X 20	200
CAPBUTXM425	CAPBUTXM425T	M4 X 25	200
CAPBUTXM430	CAPBUTXM430T	M4 X 30	200
CAPBUTXM435	CAPBUTXM435T	M4 X 35	200
CAPBUTXM58	CAPBUTXM58T	M5 X 8	200
CAPBUTXM510	CAPBUTXM510T	M5 X 10	200
CAPBUTXM512	CAPBUTXM512T	M5 X 12	200
CAPBUTXM516	CAPBUTXM516T	M5 X 16	200
CAPBUTXM520	CAPBUTXM520T	M5 X 20	200
CAPBUTXM525	CAPBUTXM525T	M5 X 25	200
CAPBUTXM530	CAPBUTXM530T	M5 X 30	200
CAPBUTXM535	CAPBUTXM535T	M5 X 35	200
CAPBUTXM540	CAPBUTXM540T	M5 X 40	200
CAPBUTXM550	CAPBUTXM550T	M5 X 50	200
CAPBUTXM68	CAPBUTXM68T	M6 X 8	200
CAPBUTXM610	CAPBUTXM610T	M6 X 10	200
CAPBUTXM612	CAPBUTXM612T	M6 X 12	200
CAPBUTXM616	CAPBUTXM616T	M6 X 16	200
CAPBUTXM620	CAPBUTXM620T	M6 X 20	200
CAPBUTXM625	CAPBUTXM625T	M6 X 25	200

PART #	PART #	SIZE	PACK QTY
CAPBUTXM630	CAPBUTXM630T	M6 X 30	200
CAPBUTXM635	CAPBUTXM635T	M6 X 35	200
CAPBUTXM640	CAPBUTXM640T	M6 X 40	200
CAPBUTXM650	CAPBUTXM650T	M6 X 50	200
CAPBUTXM660	CAPBUTXM660T	M6 X 60	200
CAPBUTXM810	CAPBUTXM810T	M8 X 10	100
CAPBUTXM812	CAPBUTXM812T	M8 X 12	100
CAPBUTXM816	CAPBUTXM816T	M8 X 16	100
CAPBUTXM820	CAPBUTXM820T	M8 X 20	100
CAPBUTXM825	CAPBUTXM825T	M8 X 25	100
CAPBUTXM830	CAPBUTXM830T	M8 X 30	100
CAPBUTXM835	CAPBUTXM835T	M8 X 35	100
CAPBUTXM840	CAPBUTXM840T	M8 X 40	100
CAPBUTXM845	CAPBUTXM845T	M8 X 45	100
CAPBUTXM850	CAPBUTXM850T	M8 X 50	100
CAPBUTXM860	CAPBUTXM860T	M8 X 60	100
CAPBUTXM870	CAPBUTXM870T	M8 X 70	100
CAPBUTXM1016	CAPBUTXM1016T	M10 X 16	100
CAPBUTXM1020	CAPBUTXM1020T	M10 X 20	100
CAPBUTXM1025	CAPBUTXM1025	M10 X 25	100
CAPBUTXM1030	CAPBUTXM1030T	M10 X 30	100
CAPBUTXM1035	CAPBUTXM1035T	M10 X 35	100
CAPBUTXM1040	CAPBUTXM1040T	M10 X 40	100
CAPBUTXM1050	CAPBUTXM1050T	M10 X 50	100
CAPBUTXM1060	CAPBUTXM1060T	M10 X 60	100
CAPBUTXM1216	CAPBUTXM1216T	M12 X 16	100
CAPBUTXM1220	CAPBUTXM1220T	M12 X 20	100
CAPBUTXM1225	CAPBUTXM1225T	M12 X 25	100
CAPBUTXM1235	CAPBUTXM1235T	M12 X 35	100
CAPBUTXM1240	CAPBUTXM1240T	M12 X 40	100
CAPBUTXM1250	CAPBUTXM1250T	M12 X 50	100

COUNTERSUNK SOCKET SCREWS 10.9

BLACK ZINC PLATED

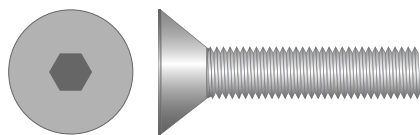

PART #	PART #	SIZE	PACK QTY
CSKSKTM25	CSKSKTM25Z	M2 X 5	100
CSKSKTM210	CSKSKTM210Z	M2 X 10	100
CSKSKTM35	CSKSKTM35Z	M3 X 5	100
CSKSKTM36	CSKSKTM36Z	M3 X 6	100
CSKSKTM38	CSKSKTM38Z	M3 X 8	100
CSKSKTM310	CSKSKTM310Z	M3 X 10	100
CSKSKTM312	CSKSKTM312Z	M3 X 12	100
CSKSKTM316	CSKSKTM316Z	M3 X 16	100
CSKSKTM320	CSKSKTM320Z	M3 X 20	100
CSKSKTM325	CSKSKTM325Z	M3 X 25	100
CSKSKTM330	CSKSKTM330Z	M3 X 30	100
CSKSKTM335	CSKSKTM335Z	M3 X 35	100
CSKSKTM45	CSKSKTM45Z	M4 X 5	100
CSKSKTM46	CSKSKTM46Z	M4 X 6	100
CSKSKTM48	CSKSKTM48Z	M4 X 8	100
CSKSKTM410	CSKSKTM410Z	M4 X 10	100
CSKSKTM412	CSKSKTM412Z	M4 X 12	100
CSKSKTM416	CSKSKTM416Z	M4 X 16	100
CSKSKTM420	CSKSKTM420Z	M4 X 20	100
CSKSKTM425	CSKSKTM425Z	M4 X 25	100
CSKSKTM430	CSKSKTM430Z	M4 X 30	100
CSKSKTM435	CSKSKTM435Z	M4 X 35	100
CSKSKTM440	CSKSKTM440Z	M4 X 40	100
CSKSKTM445	CSKSKTM445Z	M4 X 45	100
CSKSKTM450	CSKSKTM450Z	M4 X 50	100
CSKSKTM56	CSKSKTM56Z	M5 X 6	100
CSKSKTM58	CSKSKTM58Z	M5 X 8	100
CSKSKTM510	CSKSKTM510Z	M5 X 10	100
CSKSKTM512	CSKSKTM512Z	M5 X 12	100
CSKSKTM516	CSKSKTM516Z	M5 X 16	100
CSKSKTM520	CSKSKTM520Z	M5 X 20	100

PART #	PART #	SIZE	PACK QTY
CSKSKTM525	CSKSKTM525Z	M5 X 25	100
CSKSKTM530	CSKSKTM530Z	M5 X 30	100
CSKSKTM535	CSKSKTM535Z	M5 X 35	100
CSKSKTM540	CSKSKTM540Z	M5 X 40	100
CSKSKTM545	CSKSKTM545Z	M5 X 45	100
CSKSKTM550	CSKSKTM550Z	M5 X 50	100
CSKSKTM555	CSKSKTM555Z	M5 X 55	100
CSKSKTM560	CSKSKTM560Z	M5 X 60	100
CSKSKTM565	CSKSKTM565Z	M5 X 65	100
CSKSKTM570	CSKSKTM570Z	M5 X 70	100
CSKSKTM580	CSKSKTM580Z	M5 X 80	100
CSKSKTM590	CSKSKTM590Z	M5 X 90	100
CSKSKTM5100	CSKSKTM5100Z	M5 X 100	100
CSKSKTM5110	CSKSKTM5110Z	M5 X 110	25
CSKSKTM5120	CSKSKTM5120Z	M5 X 120	25
CSKSKTM68	CSKSKTM68Z	M6 X 8	100
CSKSKTM610	CSKSKTM610Z	M6 X 10	100
CSKSKTM612	CSKSKTM612Z	M6 X 12	100
CSKSKTM616	CSKSKTM616Z	M6 X 16	100
CSKSKTM620	CSKSKTM620Z	M6 X 20	100
CSKSKTM625	CSKSKTM625Z	M6 X 25	100
CSKSKTM630	CSKSKTM630Z	M6 X 30	100
CSKSKTM635	CSKSKTM635Z	M6 X 35	100
CSKSKTM640	CSKSKTM640Z	M6 X 40	100
CSKSKTM645	CSKSKTM645Z	M6 X 45	100
CSKSKTM650	CSKSKTM650Z	M6 X 50	100
CSKSKTM655	CSKSKTM655Z	M6 X 55	100
CSKSKTM660	CSKSKTM660Z	M6 X 60	50
CSKSKTM665	CSKSKTM665Z	M6 X 65	50
CSKSKTM670	CSKSKTM670Z	M6 X 70	50
CSKSKTM675	CSKSKTM675Z	M6 X 75	50

7 SOCKET SCREWS

COUNTERSUNK SOCKET SCREWS 10.9

BLACK ZINC PLATED

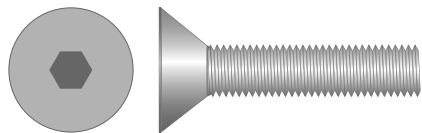

PART #	PART #	SIZE	PACK QTY
CSKSKTM680	CSKSKTM680Z	M6 X 80	50
CSKSKTM690	CSKSKTM690Z	M6 X 90	50
CSKSKTM6100	CSKSKTM6100Z	M6 X 100	50
CSKSKTM6110	CSKSKTM6110Z	M6 X 110	25
CSKSKTM6120	CSKSKTM6120Z	M6 X 120	25
CSKSKTM6160	CSKSKTM6160Z	M6 X 160	25
CSKSKTM810	CSKSKTM810Z	M8 X 10	100
CSKSKTM812	CSKSKTM812Z	M8 X 12	100
CSKSKTM816	CSKSKTM816Z	M8 X 16	100
CSKSKTM820	CSKSKTM820Z	M8 X 20	100
CSKSKTM825	CSKSKTM825Z	M8 X 25	100
CSKSKTM830	CSKSKTM830Z	M8 X 30	100
CSKSKTM835	CSKSKTM835Z	M8 X 35	100
CSKSKTM840	CSKSKTM840Z	M8 X 40	100
CSKSKTM845	CSKSKTM845Z	M8 X 45	100
CSKSKTM850	CSKSKTM850Z	M8 X 50	100
CSKSKTM855	CSKSKTM855Z	M8 X 55	50
CSKSKTM860	CSKSKTM860Z	M8 X 60	50
CSKSKTM865	CSKSKTM865Z	M8 X 65	50
CSKSKTM870	CSKSKTM870Z	M8 X 70	50
CSKSKTM875	CSKSKTM875Z	M8 X 75	50
CSKSKTM880	CSKSKTM880Z	M8 X 80	50
CSKSKTM890	CSKSKTM890Z	M8 X 90	50
CSKSKTM8100	CSKSKTM8100Z	M8 X 100	25
CSKSKTM8110	CSKSKTM8110Z	M8 X 110	25
CSKSKTM8120	CSKSKTM8120Z	M8 X 120	25
CSKSKTM8130	CSKSKTM8130Z	M8 X 130	25
CSKSKTM8140	CSKSKTM8140Z	M8 X 140	25
CSKSKTM8150	CSKSKTM8150Z	M8 X 150	25
CSKSKTM8180	CSKSKTM8180Z	M8 X 180	25
CSKSKTM8200	CSKSKTM8200Z	M8 X 200	25

PART #	PART #	SIZE	PACK QTY
CSKSKTM1010	CSKSKTM1010Z	M10 X 10	100
CSKSKTM1012	CSKSKTM1012Z	M10 X 12	100
CSKSKTM1016	CSKSKTM1016Z	M10 X 16	100
CSKSKTM1020	CSKSKTM1020Z	M10 X 20	100
CSKSKTM1025	CSKSKTM1025Z	M10 X 25	100
CSKSKTM1030	CSKSKTM1030Z	M10 X 30	100
CSKSKTM1035	CSKSKTM1035Z	M10 X 35	100
CSKSKTM1040	CSKSKTM1040Z	M10 X 40	100
CSKSKTM1045	CSKSKTM1045Z	M10 X 45	100
CSKSKTM1050	CSKSKTM1050Z	M10 X 50	100
CSKSKTM1055	CSKSKTM1055Z	M10 X 55	50
CSKSKTM1060	CSKSKTM1060Z	M10 X 60	50
CSKSKTM1065	CSKSKTM1065Z	M10 X 65	50
CSKSKTM1070	CSKSKTM1070Z	M10 X 70	50
CSKSKTM1075	CSKSKTM1075Z	M10 X 75	50
CSKSKTM1080	CSKSKTM1080Z	M10 X 80	50
CSKSKTM1090	CSKSKTM1090Z	M10 X 90	50
CSKSKTM10100	CSKSKTM10100Z	M10 X 100	25
CSKSKTM10110	CSKSKTM10110Z	M10 X 110	25
CSKSKTM10120	CSKSKTM10120Z	M10 X 120	25
CSKSKTM10130	CSKSKTM10130Z	M10 X 130	25
CSKSKTM10140	CSKSKTM10140Z	M10 X 140	25
CSKSKTM10150	CSKSKTM10150Z	M10 X 150	25
CSKSKTM1212	CSKSKTM1212Z	M12 X 12	100
CSKSKTM1216	CSKSKTM1216Z	M12 X 16	100
CSKSKTM1220	CSKSKTM1220Z	M12 X 20	100
CSKSKTM1225	CSKSKTM1225Z	M12 X 25	100
CSKSKTM1230	CSKSKTM1230Z	M12 X 30	100
CSKSKTM1235	CSKSKTM1235Z	M12 X 35	100
CSKSKTM1240	CSKSKTM1240Z	M12 X 40	100
CSKSKTM1245	CSKSKTM1245Z	M12 X 45	100

PART #	PART #	SIZE	PACK QTY
CSKSKTM1250	CSKSKTM1250Z	M12 X 50	100
CSKSKTM1255	CSKSKTM1255Z	M12 X 55	50
CSKSKTM1260	CSKSKTM1260Z	M12 X 60	50
CSKSKTM1265	CSKSKTM1265Z	M12 X 65	50
CSKSKTM1270	CSKSKTM1270Z	M12 X 70	50
CSKSKTM1275	CSKSKTM1275Z	M12 X 75	50
CSKSKTM1280	CSKSKTM1280Z	M12 X 80	50
CSKSKTM1290	CSKSKTM1290Z	M12 X 90	50
CSKSKTM12100	CSKSKTM12100Z	M12 X 100	25
CSKSKTM12110	CSKSKTM12110Z	M12 X 110	25
CSKSKTM12120	CSKSKTM12120Z	M12 X 120	25
CSKSKTM12130	CSKSKTM12130Z	M12 X 130	25
CSKSKTM12140	CSKSKTM12140Z	M12 X 140	25
CSKSKTM12150	CSKSKTM12150Z	M12 X 150	25
CSKSKTM12160	CSKSKTM12160Z	M12 X 160	25
CSKSKTM12180	CSKSKTM12180Z	M12 X 180	25
CSKSKTM12190	CSKSKTM12190Z	M12 X 190	25
CSKSKTM12200	CSKSKTM12200Z	M12 X 200	25
CSKSKTM12220	CSKSKTM12220Z	M12 X 220	10
CSKSKTM1425	CSKSKTM1425Z	M14 X 25	50
CSKSKTM1430	CSKSKTM1430Z	M14 X 30	50
CSKSKTM1440	CSKSKTM1440Z	M14 X 40	50
CSKSKTM1445	CSKSKTM1445Z	M14 X 45	50
CSKSKTM1450	CSKSKTM1450Z	M14 X 50	50
CSKSKTM1455	CSKSKTM1455Z	M14 X 55	50
CSKSKTM1460	CSKSKTM1460Z	M14 X 60	50
CSKSKTM1470	CSKSKTM1470Z	M14 X 70	50
CSKSKTM1475	CSKSKTM1475Z	M14 X 75	50
CSKSKTM1480	CSKSKTM1480Z	M14 X 80	50
CSKSKTM1490	CSKSKTM1490Z	M14 X 90	50
CSKSKTM14100	CSKSKTM14100Z	M14 X 100	50

PART #	PART #	SIZE	PACK QTY
CSKSKTM14110	CSKSKTM14110Z	M14 X 110	25
CSKSKTM14120	CSKSKTM14120Z	M14 X 120	25
CSKSKTM1625	CSKSKTM1625Z	M16 X 25	50
CSKSKTM1630	CSKSKTM1630Z	M16 X 30	50
CSKSKTM1635	CSKSKTM1635Z	M16 X 35	50
CSKSKTM1640	CSKSKTM1640Z	M16 X 40	50
CSKSKTM1645	CSKSKTM1645Z	M16 X 45	50
CSKSKTM1650	CSKSKTM1650Z	M16 X 50	50
CSKSKTM1655	CSKSKTM1655Z	M16 X 55	50
CSKSKTM1660	CSKSKTM1660Z	M16 X 60	25
CSKSKTM1665	CSKSKTM1665Z	M16 X 65	25
CSKSKTM1670	CSKSKTM1670Z	M16 X 70	25
CSKSKTM1675	CSKSKTM1675Z	M16 X 75	25
CSKSKTM1680	CSKSKTM1680Z	M16 X 80	25
CSKSKTM1690	CSKSKTM1690Z	M16 X 90	25
CSKSKTM16100	CSKSKTM16100Z	M16 X 100	10
CSKSKTM16110	CSKSKTM16110Z	M16 X 110	10
CSKSKTM16120	CSKSKTM16120Z	M16 X 120	10
CSKSKTM16130	CSKSKTM16130Z	M16 X 130	10
CSKSKTM16140	CSKSKTM16140Z	M16 X 140	10
CSKSKTM16150	CSKSKTM16150Z	M16 X 150	10
CSKSKTM2030	CSKSKTM2030Z	M20 X 30	25
CSKSKTM2035	CSKSKTM2035Z	M20 X 35	25
CSKSKTM2040	CSKSKTM2040Z	M20 X 40	25
CSKSKTM2045	CSKSKTM2045Z	M20 X 45	25
CSKSKTM2050	CSKSKTM2050Z	M20 X 50	25
CSKSKTM2055	CSKSKTM2055Z	M20 X 55	25
CSKSKTM2060	CSKSKTM2060Z	M20 X 60	25
CSKSKTM2065	CSKSKTM2065Z	M20 X 65	25
CSKSKTM2070	CSKSKTM2070Z	M20 X 70	25
CSKSKTM2075	CSKSKTM2075Z	M20 X 75	25

7 SOCKET SCREWS

COUNTERSUNK SOCKET SCREWS 10.9

BLACK ZINC PLATED

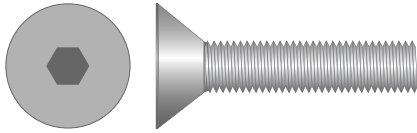

PART #	PART #	SIZE	PACK QTY
CSKSKTM2080	CSKSKTM2080Z	M20 X 80	25
CSKSKTM2090	CSKSKTM2090Z	M20 X 90	25
CSKSKTM20100	CSKSKTM20100Z	M20 X 100	25
CSKSKTM20110	CSKSKTM20110Z	M20 X 110	10
CSKSKTM20120	CSKSKTM20120Z	M20 X 120	10
CSKSKTM20130	CSKSKTM20130Z	M20 X 130	10
CSKSKTM20140	CSKSKTM20140Z	M20 X 140	10
CSKSKTM20150	CSKSKTM20150Z	M20 X 150	10
CSKSKTM20180	CSKSKTM20180Z	M20 X 180	10
CSKSKTM20200	CSKSKTM20200Z	M20 X 200	10
CSKSKTM2440	CSKSKTM2440Z	M24 X 40	25
CSKSKTM2450	CSKSKTM2450Z	M24 X 50	25
CSKSKTM2460	CSKSKTM2460Z	M24 X 60	25
CSKSKTM2475	CSKSKTM2475Z	M24 X 75	10
CSKSKTM2480	CSKSKTM2480Z	M24 X 80	10
CSKSKTM2490	CSKSKTM2490Z	M24 X 90	10
CSKSKTM24100	CSKSKTM24100Z	M24 X 100	10
CSKSKTM24120	CSKSKTM24120Z	M24 X 120	10
CSKSKTM24130	CSKSKTM24130Z	M24 X 130	10
CSKSKTM24140	CSKSKTM24140Z	M24 X 140	10
CSKSKTM24150	CSKSKTM24150Z	M24 X 150	10
CSKSKTM24160	CSKSKTM24160Z	M24 X 160	10
CSKSKTM24180	CSKSKTM24180Z	M24 X 180	10
CSKSKTM24200	CSKSKTM24200Z	M24 X 200	10

COUNTERSUNK SOCKET SCREWS 10.9

BLACK - IMPERIAL

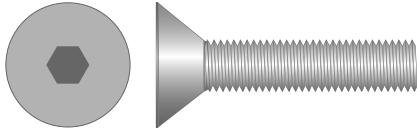

PART #	SIZE	PACK QTY
CSKSKT3161	3/16 X 1"	100
CSKSKT316112	3/16 X 1 1/2"	50
CSKSKT316114	3/16 X 1 1/4"	25
CSKSKT31612	3/16 X 1/2"	25
CSKSKT3162	3/16 X 2"	50
CSKSKT31634	3/16 X 3/4"	50
CSKSKT141	1/4 X 1"	50
CSKSKT1412	1/4 X 1/2"	50
CSKSKT142	1/4 X 2"	50
CSKSKT1434	1/4 X 3/4"	50
CSKSKT1458	1/4 X 5/8"	50
CSKSKT14112	1/4 X 1-1/2"	100
CSKSKT14114	1/4 X 1-1/4"	100
CSKSKT5161	5/16 X 1"	100
CSKSKT5162	5/16 X 2"	50
CSKSKT516112	5/16 X 1-1/2"	100
CSKSKT516114	5/16 X 1-1/4"	100
CSKSKT51634	5/16 X 3/4"	100
CSKSKT51658	5/16 X 5/8"	100
CSKSKT381	3/8 X 1"	100
CSKSKT382	3/8 X 2"	100
CSKSKT383	3/8 X 3"	25
CSKSKT3834	3/8 X 3/4"	25
CSKSKT38112	3/8 X 1-1/2"	25

PART #	SIZE	PACK QTY
CSKSKT38114	3/8 X 1-1/4"	25
CSKSKT38134	3/8 X 1-3/4"	100
CSKSKT121C	1/2 X 1"	100
CSKSKT123C	1/2 X 3"	100
CSKSKT1234C	1/2 X 3/4"	10
CSKSKT12112C	1/2 X 1-1/2"	10
CSKSKT12114C	1/2 X 1-1/4"	10
CSKSKT12134C	1/2 X 1-3/4"	10
CSKSKT122C	1/2 X 2"	50
CSKSKT12212C	1/2 X 2-1/2"	50
CSKSKT582	5/8 X 2"	100
CSKSKT583	5/8 X 3"	100
CSKSKT584	5/8 X 4"	100
CSKSKT58212	5/8 X 2-1/2"	100
CSKSKT58214	5/8 X 2-1/4"	100
CSKSKT342	3/4 X 2"	100
CSKSKT343	3/4 X 3"	100
CSKSKT344	3/4 X 4"	100
CSKSKT34212	3/4 X 2-1/2"	100
CSKSKT15	1" X 5"	100
CSKSKT16	1" X 6"	100
CSKSKT17	1" X 7"	100
CSKSKT18	1" X 8"	100

7 SOCKET SCREWS

COUNTERSUNK SOCKET SCREWS

STAINLESS STEEL T304 STAINLESS STEEL T316

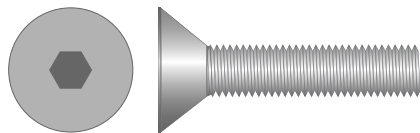

PART #	PART #	SIZE	PACK QTY
CSKSKTXM38	CSKSKTXM38T	M3 X 8	200
CSKSKTXM310	CSKSKTXM310T	M3 X 10	200
CSKSKTXM312	CSKSKTXM312T	M3 X 12	200
CSKSKTXM316	CSKSKTXM316T	M3 X 16	200
CSKSKTXM320	CSKSKTXM320T	M3 X 20	200
CSKSKTXM48	CSKSKTXM48T	M4 X 8	200
CSKSKTXM410	CSKSKTXM410T	M4 X 10	200
CSKSKTXM412	CSKSKTXM412T	M4 X 12	200
CSKSKTXM416	CSKSKTXM416T	M4 X 16	200
CSKSKTXM420	CSKSKTXM420T	M4 X 20	200
CSKSKTXM425	CSKSKTXM425T	M4 X 25	200
CSKSKTXM430	CSKSKTXM430T	M4 X 30	200
CSKSKTXM4440	CSKSKTXM4440T	M4 X 40	200
CSKSKTXM58	CSKSKTXM58T	M5 X 8	200
CSKSKTXM510	CSKSKTXM510T	M5 X 10	200
CSKSKTXM512	CSKSKTXM512T	M5 X 12	200
CSKSKTXM516	CSKSKTXM516T	M5 X 16	200
CSKSKTXM520	CSKSKTXM520T	M5 X 20	200
CSKSKTXM525	CSKSKTXM525T	M5 X 25	200
CSKSKTXM530	CSKSKTXM530T	M5 X 30	200
CSKSKTXM535	CSKSKTXM535T	M5 X 35	200
CSKSKTXM540	CSKSKTXM540T	M5 X 40	200
CSKSKTXM545	CSKSKTXM545T	M5 X 45	200
CSKSKTXM550	CSKSKTXM550T	M5 X 50	200
CSKSKTXM68	CSKSKTXM68T	M6 X 8	200
CSKSKTXM610	CSKSKTXM610T	M6 X 10	200
CSKSKTXM612	CSKSKTXM612T	M6 X 12	200
CSKSKTXM616	CSKSKTXM616T	M6 X 16	200
CSKSKTXM620	CSKSKTXM620T	M6 X 20	200
CSKSKTXM625	CSKSKTXM625T	M6 X 25	200
CSKSKTXM630	CSKSKTXM630T	M6 X 30	200
CSKSKTXM635	CSKSKTXM635T	M6 X 35	200

PART #	PART #	SIZE	PACK QTY
CSKSKTXM640	CSKSKTXM640T	M6 X 40	200
CSKSKTXM650	CSKSKTXM650T	M6 X 50	200
CSKSKTXM660	CSKSKTXM660T	M6 X 60	100
CSKSKTXM670	CSKSKTXM670T	M6 X 70	100
CSKSKTXM680	CSKSKTXM680T	M6 X 80	100
CSKSKTXM6100	CSKSKTXM6100T	M6 X 100	100
CSKSKTXM812	CSKSKTXM812T	M8 X 12	100
CSKSKTXM816	CSKSKTXM816T	M8 X 16	100
CSKSKTXM820	CSKSKTXM820T	M8 X 20	100
CSKSKTXM825	CSKSKTXM825T	M8 X 25	100
CSKSKTXM830	CSKSKTXM830T	M8 X 30	100
CSKSKTXM835	CSKSKTXM835T	M8 X 35	100
CSKSKTXM840	CSKSKTXM840T	M8 X 40	100
CSKSKTXM845	CSKSKTXM845T	M8 X 45	100
CSKSKTXM850	CSKSKTXM850T	M8 X 50	100
CSKSKTXM855	CSKSKTXM855T	M8 X 55	100
CSKSKTXM860	CSKSKTXM860T	M8 X 60	100
CSKSKTXM870	CSKSKTXM870T	M8 X 70	100
CSKSKTXM880	CSKSKTXM880T	M8 X 80	100
CSKSKTXM8100	CSKSKTXM8100T	M8 X 100	100
CSKSKTX1020	CSKSKTX1020T	M10 X 20	100
CSKSKTX1025	CSKSKTX1025T	M10 X 25	100
CSKSKTX1030	CSKSKTX1030T	M10 X 30	100
CSKSKTX1035	CSKSKTX1035T	M10 X 35	100
CSKSKTX1040	CSKSKTX1040T	M10 X 40	100
CSKSKTX1050	CSKSKTX1050T	M10 X 50	100
CSKSKTX1060	CSKSKTX1060T	M10 X 60	100
CSKSKTX1070	CSKSKTX1070T	M10 X 70	100
CSKSKTX1080	CSKSKTX1080T	M10 X 80	100
CSKSKTX1090	CSKSKTX1090T	M10 X 90	100
CSKSKTX10100	CSKSKTX10100T	M10 X 100	100
CSKSKTX1225	CSKSKTX1225T	M12 X 25	100

PART #	PART #	SIZE	PACK QTY
CSKSKTX1230	CSKSKTX1230T	M12 X 30	100
CSKSKTX1235	CSKSKTX1235T	M12 X 35	100
CSKSKTX1240	CSKSKTX1240T	M12 X 40	100
CSKSKTX1245	CSKSKTX1245T	M12 X 45	100
CSKSKTX1250	CSKSKTX1250	M12 X 50	100
	CSKSKTXM1260T	M12 X 60	100
	CSKSKTXM1270T	M12 X 70	100
	CSKSKTXM1280T	M12 X 80	100
	CSKSKTXM1635T	M16 X 35	100
	CSKSKTXM640T	M16 X 40	100
	CSKSKTXM1650T	M16 X 50	100

7 SOCKET SCREWS

GRUB SCREWS

BLACK

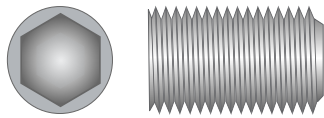

PART #	PART #	SIZE
GRUBM33	M3 X 3	100
GRUBM34	M3 X 4	100
GRUBM35	M3 X 5	100
GRUBM36	M3 X 6	100
GRUBM38	M3 X 8	100
GRUBM310	M3 X 10	100
GRUBM44	M4 X 4	100
GRUBM45	M4 X 5	100
GRUBM46	M4 X 6	100
GRUBM48	M4 X 8	100
GRUBM410	M4 X 10	100
GRUBM412	M4 X 12	100
GRUBM416	M4 X 16	100
GRUBM420	M4 X 20	100
GRUBM55	M5 X 5	100
GRUBM56	M5 X 6	100
GRUBM58	M5 X 8	100
GRUBM510	M5 X 10	100
GRUBM512	M5 X 12	100
GRUBM516	M5 X 16	100
GRUBM520	M5 X 20	100
GRUBM525	M5 X 25	100
GRUBM530	M5 X 30	100
GRUBM66	M6 X 6	100
GRUBM68	M6 X 8	100
GRUBM610	M6 X 10	100
GRUBM612	M6 X 12	100
GRUBM616	M6 X 16	100
GRUBM620	M6 X 20	100
GRUBM625	M6 X 25	100
GRUBM630	M6 X 30	100
GRUBM640	M6 X 40	100

PART #	PART #	SIZE
GRUBM88	M8 X 8	100
GRUBM810	M8 X 10	100
GRUBM812	M8 X 12	100
GRUBM816	M8 X 16	100
GRUBM820	M8 X 20	100
GRUBM825	M8 X 25	100
GRUBM830	M8 X 30	100
GRUBM840	M8 X 40	100
GRUBM1010	M10 X 10	100
GRUBM1012	M10 X 12	100
GRUBM1016	M10 X 16	100
GRUBM1020	M10 X 20	100
GRUBM1025	M10 X 25	100
GRUBM1030	M10 X 30	100
GRUBM1035	M10 X 35	100
GRUBM1040	M10 X 40	100
GRUBM1050	M10 X 50	100
GRUBM1212	M12 X 12	100
GRUBM1216	M12 X 16	100
GRUBM1220	M12 X 20	100
GRUBM1225	M12 X 25	100
GRUBM1230	M12 X 30	100
GRUBM1240	M12 X 40	100
GRUBM1250	M12 X 50	50
GRUBM1616	M16 X 16	50
GRUBM1620	M16 X 20	50
GRUBM1625	M16 X 25	50
GRUBM1630	M16 X 30	50
GRUBM1640	M16 X 40	50
GRUBM1660	M16 X 60	50
GRUBM2025	M20 X 25	25
GRUBM2030	M20 X 30	50

GRUB SCREWS

BLACK - IMPERIAL

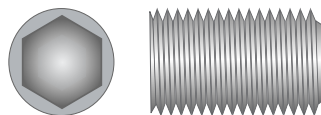

PART #	PART #	SIZE
GRUBM2040	M20 X 40	50
GRUBM2050	M20 X 50	50
GRUBM2060	M20 X 60	25
GRUBM2425	M24 X 25	25
GRUBM2430	M24 X 30	25
GRUBM2440	M24 X 40	25
GRUBM2450	M24 X 50	25
GRUBM2460	M24 X 60	25

PART #	SIZE	PACK QTY
GRUB141	1/4 X 1"	100
GRUB1412	1/4 X 1/2	100
GRUB1414	1/4 X 1/4	100
GRUB1434	1/4 X 3/4	100
GRUB1438	1/4 X 3/8	100
GRUB1458	1/4 X 5/8	100
GRUB	1/4 X 5/16	100
GRUB516112	5/16 X 1-1/2	100
GRUB516114	5/16 X 1-1/4	100
GRUB51612	5/16 X 1/2	100
GRUB51634	5/16 X 3/4	100
GRUB51638	5/16 X 3/8	100
GRUB216516	5/16 X 5/16	100
GRUB51658	5/16 X 5/8	100
GRUB381	3/8 X 1"	25
GRUB3838	3/8 X 3/8	25
GRUB121	1/2 X 1"	50
GRUB1212	1/2 X 1/2	50
GRUB1234	1/2 X 3/4	50
GRUB1258	1/2 X 5/8	50
GRUB12112	1/2 X 1-1/2	50
GRUB12114	1/2 X 1-1/4	50
GRUB581	5/8 X 1"	25
GRUB5834	5/8 X 3/4	25
GRUB5858	5/8 X 5/8	25
GRUB583	5/8 X 3"	25

7 SOCKET SCREWS

SHOULDER CAP SCREWS

BLACK

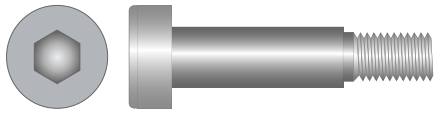

PART #	PART #	PACK QTY
CAPSHM612	6 (M5) X 12	25
CAPSHM616	6 (M5) X 16	25
CAPSHM620	6 (M5) X 20	25
CAPSHM625	6 (M5) X 25	25
CAPSHM630	6 (M5) X 30	25
CAPSHM640	6 (M5) X 40	25
CAPSHM812	8 (M6) X 12	25
CAPSHM816	8 (M6) X 16	25
CAPSHM820	8 (M6) X 20	25
CAPSHM825	8 (M6) X 25	25
CAPSHM830	8 (M6) X 30	25
CAPSHM840	8 (M6) X 40	25
CAPSHM850	8 (M6) X 50	25
CAPSHM1020	10 (M8) X 20	25
CAPSHM1025	10 (M8) X 25	25
CAPSHM1030	10 (M8) X 30	25
CAPSHM1050	10 (M8) X 50	25
CAPSHM1060	10 (M8) X 60	25
CAPSHM1220	12 (M10) X 20	25

PART #	PART #	PACK QTY
CAPSHM1225	12 (M10) X 25	25
CAPSHM1230	12 (M10) X 30	25
CAPSHM1240	12 (M10) X 40	25
CAPSHM1630	16 (M12) X 30	25
CAPSHM1640	16 (M12) X 40	25
CAPSHM1650	16 (M12) X 50	25
CAPSHM1660	16 (M12) X 60	25
CAPSHM1670	16 (M12) X 70	25
CAPSHM2040	20 (M16) X 40	10
CAPSHM2050	20 (M16) X 50	10
CAPSHM2060	20 (M16) X 60	10
CAPSHM2080	20 (M16) X 80	10
CAPSHM2090	20 (M16) X 90	10
CAPSHM20100	20 (M16) X 100	10
CAPSHM2460	24 (M20) X 60	10
CAPSHM2470	24 (M20) X 70	10
CAPSHM2480	24 (M20) X 80	5
CAPSHM2490	24 (M20) X 90	5

Fortress Fasteners Enquiries

0800 42 52 62 | sales@steelandtube.co.nz | steelandtube.co.nz

8 RIVETS



8 RIVETS

DOMED RIVETS

ALUMINIUM / STEEL STEM



PART #	SIZE	GRIP mm	PACK QTY	JAR QTY
R73AS42	3.2 X 6.7mm	1.6-3.2	1000	100
R73AS43	3.2 X 8.2mm	3.2-4.8	1000	100
R73AS44	3.2 X 9.9mm	4.8-6.4	1000	100
R73AS45	3.2 X 11.4mm	6.4-8.0	1000	100
R73AS46	3.2 X 13.0mm	8.0-9.5	1000	100
R73AS48	3.2 X 16.1mm	9.5-12.7	1000	100
R73AS410	3.2 X 19.4mm	12.7-15.8	1000	100

R73AS52	4.0 X 5.5mm	1.6-3.2	1000	
R73AS53	4.0 X 7.3mm	3.2-4.8	1000	100
R73AS54	4.0 X 10.5mm	4.8-6.4	1000	100
R73AS55	4.0 X 12.0mm	6.4-8.0	1000	100
R73AS56	4.0 X 13.6mm	8.0-9.5	1000	100
R73AS58	4.0 X 16.8mm	9.5-12.7	500	50
R73AS10	4.0 X 19.5mm	12.7-15.8	500	

R73AS63	4.8 X 8.0mm	3.2-4.8	500	50
R73AS64	4.8 X 9.5mm	4.8-6.4	500	50
R73AS65	4.8 X 11.1mm	6.4-8.0	500	50
R73AS66	4.8 X 14.3mm	8.0-9.5	500	50
R73AS68	4.8 X 17.5mm	9.5-12.7	500	50
R73AS610	4.8 X 20.7mm	12.7-15.8	500	25
R73AS612	4.8 X 23.8mm	15.8-19.0	250	25
R73AS614	4.8 X 27.0mm	19.0-22.2	250	50
R73AS620	4.8 X 35.0mm	25.4-31.8	250	

DOMED RIVETS

STEEL



PART #	SIZE	GRIP mm	PACK QTY	
R73SS43	3.2 X 8.0mm	3.2-4.8	1000	100
R73SS44	3.2 X 9.6mm	4.8-6.4	1000	100
R73SS45	3.2 X 11.1mm	6.4-8.0	1000	100
R73SS46	3.2 X 12.7mm	8.0-9.5	1000	100

R73SS53	4.0 X 7.1mm	3.2-4.8	1000	100
R73SS54	4.0 X 10.2mm	4.8-6.4	1000	100
R73SS56	4.0 X 13.4mm	8.0-9.5	500	100
R73SS58	4.0 X 16.5mm	9.5-12.7	500	50

R73SS63	4.8 X 8.0mm	3.2-8.0	500	50
R73SS64	4.8 X 9.6mm	4.8-6.4	500	
R73SS65	4.8 X 11.0mm	6.4-8.0	500	50
R73SS66	4.8 X 14.5mm	8.0-9.5	500	50

STAINLESS STEEL



PART #	SIZE	GRIP mm	PACK QTY	
R73STST46	3.2 X 12.7mm	8.0-9.5	1000	100

R73STST52	4.0 X 7.1mm	1.6 -3.2	500	
R73STST54	4.0 X 8.6mm	3.2-4.8	500	
R73STST55	4.0 X 9.6mm	4.8-6.4	500	
R73STST56	4.0 X 13.0mm	8.0-9.5	500	

R73STST63	4.8 X 7.9mm	3.2-8.0	500	
R73STST65	4.8 X 11.1mm	6.4-8.0	250	
R73STST66	4.8 X 13.5mm	8.0-9.5	250	
R73STST68	4.8 X 17.5mm	9.5-12.7	250	

8 RIVETS

COUNTERSUNK RIVETS

ALUMINIUM / STEEL STEM

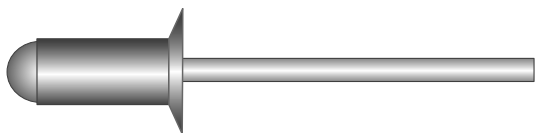

PART #	SIZE	GRIP mm	PACK QTY
R72AS44	3.2 X 9.6mm	4.8-6.4	250
R72AS46	3.2 X 12.7mm	8.0-9.5	250
R72AS53	4.0 X 7.1mm	3.2-4.8	250
R72AS54	4.0 X 10.2mm	4.8-6.4	250
R72AS63	4.8 X 8.00mm	3.2-4.8	500
R72AS65	4.8 X 11.00mm	6.4-8.0	500
R72AS66	4.8 X 12.7mm	8.0-9.5	500
R72AS68	4.8 X 14.5mm	9.5-12.7	500
R72AS610	4.8 X 21.00mm	12.7-15.8	250

LARGE FLANGE RIVETS

ALUMINIUM / STEEL STEM

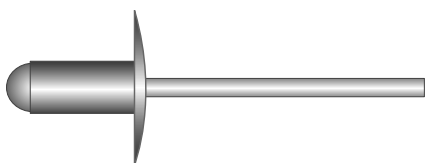

PART #	SIZE	GRIP mm	PACK QTY
R73ASL44	3.2 X 9.6mm	4.8-6.4	250
R73ASL48	3.2 X 16.1mm	9.5-12.7	250
R73ASL66	4.8 X 14.5mm	8.0-9.5	250
R73ASL68	4.8 X 17.7mm	9.5-12.7	250
R73ASL610	4.8 X 21.0mm	12.7-15.8	250
R73ASL612	4.8 X 24.1mm	15.8-19.0	250
R73ASL614	4.8 X 27.0mm	19.0-22.2	250

RIVETS

TECHNICAL INFORMATION

MATERIALS		COMMON DEFINITIONS	
ALUMINIUM	5050	73	DOMED
STEEL	1010	72	COUNTERSUNK
STAINLESS STEEL	T304	AS	ALUMINIUM BODY STEEL STEM
		STST	STAINLESS BODY STAINLESS STEM
		AA	ALUMINIUM BODY ALUMINIUM STEM
		SS	STEEL STEM STEEL BODY
		CS	COPPER BODY STEEL STEM
		ASL	ALUMINIUM/STEEL LARGE FLANGE

RIVET SIZE			THICKNESS TO BE RIVETED			
	BODY DIAMETER	DRILL SIZE	mm	USE RIVET SIZE		
NO 4	3.2mm	3.3mm	1.6 TO 3.2	4.2	5.2	6.2
NO 5	4.0mm	4.1mm	3.2 TO 4.8	4.3	5.3	6.3
NO 6	4.8mm	4.9mm	4.8 TO 6.4	4.4	5.4	6.4
			6.4 TO 8.0	4.5	5.5	6.5
			8.0 TO 9.5	4.6	5.6	6.6
			9.5 TO 12.5	4.8	5.8	6.8
			12.5 TO 16.0	4.10	5.10	6.10
			16.0 TO 19.0			6.12
			19.0 TO 22.0			6.14

STRENGTH KN MINIMUM

SIZE	ALUMINIUM		STAINLESS STEEL	
	SHEAR	TENSILE	SHEAR	TENSILE
NO 4	0.53	0.67	1.86	2.35
NO 5	0.85	1.02	2.90	3.65
NO 6	1.15	1.42	4.22	5.33

SIZE	STEEL		MONEL	
	SHEAR	TENSILE	SHEAR	TENSILE
NO 4	1.16	1.38	1.16	1.38
NO 5	1.65	2.10	1.65	2.10
NO 6	2.40	3.02	2.40	3.02

**RELIABLE,
HIGH-QUALITY
FASTENERS
DESIGNED
TO PERFORM
FOR EVERY
PROJECT WITH
STRENGTH AND
PRECISION.**

Fortress Fasteners Enquiries

0800 42 52 62 | sales@steelandtube.co.nz | steelandtube.co.nz



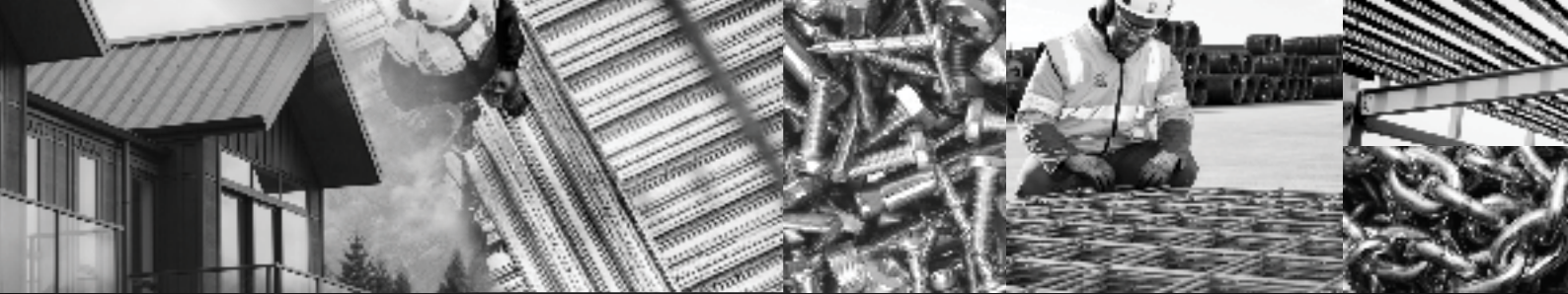

NATIONWIDE STEEL SOLUTIONS

Steel & Tube offers a comprehensive range of steel related products and services through a nationwide distribution and processing network, so no matter where you are in the country we can deliver product to you.

As experts in our field, we pride ourselves in being able to offer a consistent end-to-end customer experience, advising, sourcing and supplying customers with their steel requirements. And underlying everything we do, is our continued commitment to quality.







Fortress Fasteners Enquiries

0800 425 262 | sales@steelandtube.co.nz

Steel	0800 478 335	Roofing & Cladding	0800 427 663
Aluminium		HST Purlins & Top Hats	0800 278 754
Mesh & Reinforcing		Reticulation, Pipe & Cable Supports	0800 474 735
Coil & Sheet		Chain & Rigging	0800 100 260
Plate Processing	0800 426 787	Hurricane Rural & Fencing	0800 800 947
Stainless Steel		ComFlor (CFDL)	0508 332 546
Architectural Stainless		Galvanizing	0800 508 506
Fortress Fasteners		Grating	0800 425 848
Consumable Supplies	0800 425 262	Sandblasting	07 849 1332

Contact us form
steelandtube.co.nz/contact

Webshop
portal.steelandtube.co.nz

Follow us    



0800 478 335 steelandtube.co.nz